

ArcelorMittal Europe - Long products
Sections and Merchant Bars



ArcelorMittal

ACB® and Angelina® beams

A new generation of beams with large web openings



Exposed cellular beams in a roof application at a motorway services



Table of contents

1. Introduction.....	5
2. Typical applications.....	7
3. Design and fabrication.....	9
4. Tolerances of ACB® and Angelina® beams.....	16
5. Beams with large web openings in roof and non-composite floor applications.....	19
6. Beams with large web openings in composite floor systems.....	23
7. Stability under fire conditions	27
8. ACB® and Angelina® beams: a solution for sustainable constructions.....	28
9. Predesign software.....	31
10. Predesign charts of beams with large web openings.....	32
11. Predesign charts for ACB®	36
12. Predesign charts for Angelina®	51
13. Our support to your project	63



1. Introduction

ACB® and Angelina® beams, with their circular and sinusoidal large web openings, elegantly combine function with flexibility. Alternatives to trusses and open-web joist systems, beams with large web openings are lightweight, long-spanning, structural elements that enable the design of vast column-free spaces. They can be used in composite and non-composite systems.

This flexibility is further enhanced by being able to accommodate services through the large web openings. The airy aspect of these beams, combined with their high strength, continuously inspire architects to create new shapes.

Their large web openings enable installation of mechanical, electrical and plumbing (MEP) pipes and ducts within the depth of the beam, thereby allowing for compact ceiling systems and maximised floor-to-ceiling heights. In addition, the repetition of the perforations ensures that variations, during construction or throughout the life of the structure, in the layout of the MEP system can easily be accommodated.

Architecturally striking, cellular ACB® and Angelina® beams are every year seeing increased use in the built environment. Today, with improvements that have been implemented in design standards, analysis tools, and manufacturing, it is easier than ever to incorporate them into a framing system.

- **Manufacturing**

Optimised manufacturing methods, including flame cutting and bending, enable cost-effective production of ACB® and Angelina® beams, even though they are customised to meet individual project needs. In addition, production efficiency leads to quick despatch of the sections for final fabrication. The availability of a wide range of hot-rolled sections and grades, including S460, guarantees cost-efficiency.

- **Design standards**

Eurocode 3 for steel structures and Eurocode 4 for composite

structures provide guidance on the design of cellular beams. Information includes analysis recommendations for use of these elements in traditional applications, such as floors and roofs; assumptions when considering how the sections will behave in response to fire; and information about using cellular beams fabricated from S460 high-strength steel.

- **Composite construction**

The development of the various aspects of composite construction – connections, steel decking, large floor areas without expansion joints (up to 80m and even more), fire resistance, user comfort and durability – has greatly contributed to the wider use of ACB® and Angelina® beams solution in floors.

- **Analysis tools**

To facilitate easy analysis of cellular beams, two software systems have been developed and made available to engineering offices and architects: ACB+ and ANGELINA. These tools allow optimal choice of section, opening depth and spacing, and also steel grade, all to the specific requirements of the project. They also take account of Eurocode design principles as well as results of full-scale tests and numerical simulations. With ACB+ and ANGELINA, users can determine optimal system weights, based on section size, opening depth, width and distance and determine the impact that varying steel grade will have on the solution. These systems are designed to assist engineers and architects to find the most efficient, economical cellular beam solutions.

- **Smart use**

The use of ACB® and Angelina® beams leads to reduced floor zones and simplifies the construction, keeping the structure elegant. The installation of mechanical and electrical services (MEP) is facilitated through the large web openings. Future variations to the MEP system, either during construction or throughout the life of the structure, are easily accommodated without any structural change due to the multiple, regular spaced web openings.

- **Technical fabrication**

ACB® and Angelina® beams are manufactured from standard hot-rolled steel sections. The length of the beam is established based from the framing layout. Dimensions that define the shape and layout of the openings – i.e. a_0 (opening, depth), s (length of sinusoidal curve), and w (length of the intermediate web post) – are governed by strength and serviceability requirements and will be verified by the designer.

ACB® - Cellular beam with circular large web openings

Angelina® - Beam with sinusoidal large web openings

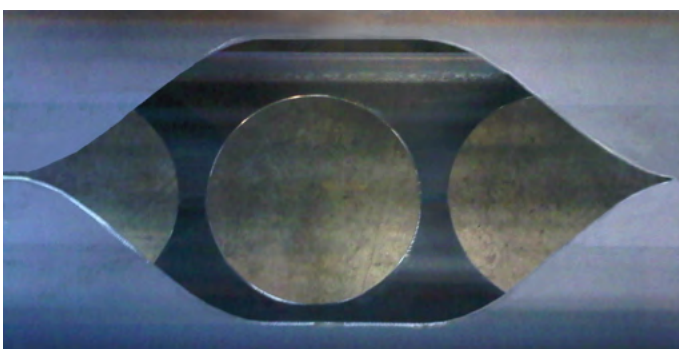
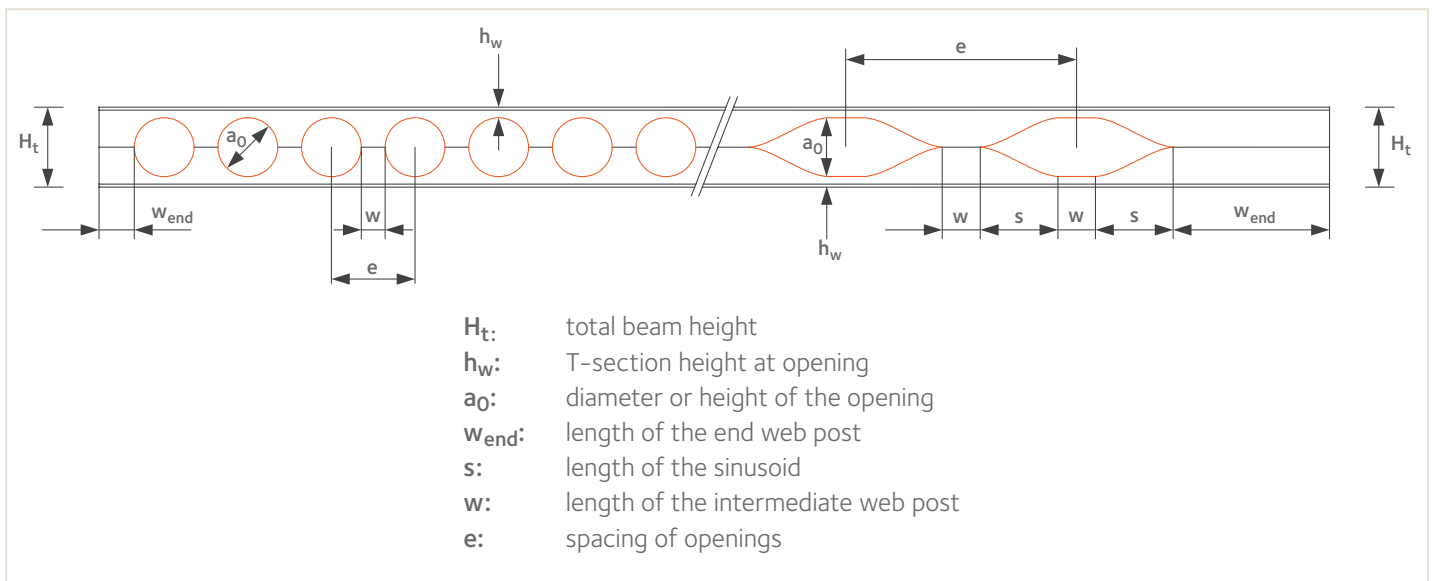

Figure 1: Comparison of web openings of ACB® and Angelina® beams

2. Typical applications

2.1. Roof support systems

ACB® and Angelina® beams are an attractive solution in roof applications as they provide the functionality of trusses with one simple, prefabricated element. When used as long span roof members cellular beams are economical for spans of 20m and above, and have successfully been used for spans in excess of 40m. They can be used as simply supported members, cantilever elements or as part of moment or portal frame structures.

By employing ACB® and Angelina® beams, designers can achieve light, airy spaces that are attractive to building owners. The height of the openings can reach 80 % of the total beam depth and as a result of efficient fabrication methods, it is possible to minimise the distance between openings. These characteristics of cellular beams result in seemingly transparent design solutions that blend elegantly into their built environment.

Figure 2: ACB® roof beams



2.2. Floor support systems

Modern construction increasingly demands accommodation of building services (heating, ventilation, air conditioning, etc.) as well as structural support within minimal ceiling spaces (Fig. 3). Cellular beams provide efficient solutions to meet these demands, allowing pipes and ducts to pass through their openings while having the capacity to span in excess of 20m thereby providing large, column-free floor areas.

With ACB® and Angelina® beams, floor thickness can be reduced by 250 to 400mm, when compared to conventional solutions. For typical buildings, with a height limit of 35 to 40m, a gain of 200mm per floor enables the addition of one floor within the same construction height. For buildings with a limit on number of floors, minimising the floor-to-floor height results in cost efficiencies with respect to the façade, columns, stabilising structures, separating walls and vertical access walls.

Figure 3: Angelina® floor beam





Studios d'Architecture ORY & Associés

Figure 4: Renovation using ACB® beams at headquarters of Crédit Lyonnais, Paris

2.3. Specialty applications

2.3.1. Building renovations and adaptive reuse

ACB® and Angelina® beams are often employed in the renovation and adaptive reuse of existing structures (Fig. 4). With their perforations, they fit in beautifully to such buildings and help to preserve architecture, openness and flexibility of the spaces.

often dark spaces. In addition, the openings facilitate smoke evacuation and improved air circulation between sections. Cellular beams can be cambered as part of the production process to allow runoff from rain, snow and ice accumulation.

2.3.2. Parking structures

Cellular beams bring lightweight, adaptable solutions to car parks and serve as an economical alternative to precast concrete tees (Fig. 5). Easily spanning the 15 to 16 meters required by typical parking structures, the open webs of ACB® and Angelina® beams allow natural light to flood these

2.3.3 Beams for offshore structures

For cases where this industry requires:

- a framework combining strength with low weight,
 - the possibility of passing pipes and ducts,
- it is clear that cellular beams are to be recommended, given their characteristics. In cases of particularly high loading, the use of HISTAR® steels is recommended.

Figure 5: Cellular beams used in parking structures



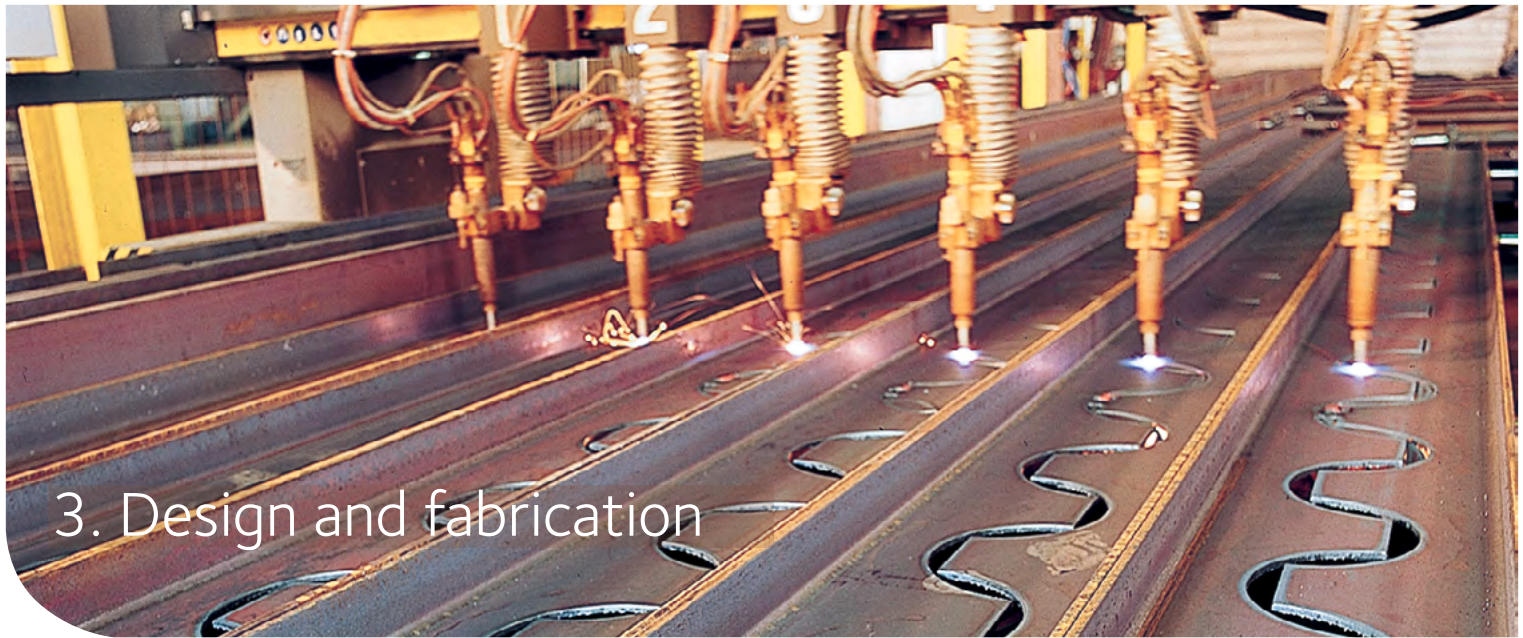

3. Design and fabrication

Flame cutting of hot rolled sections

ACB® and Angelina® beams are fabricated exclusively using hot-rolled structural sections. The fabrication shop is located close to the ArcelorMittal Differdange (Luxembourg) heavy section rolling mill. The close proximity of these two sites limits transport, maximises responsiveness and minimises manufacturing costs.

Fabrication of ACB® and Angelina® beams, is described below and illustrated in Fig. 6:

A double (ACB®) or single (Angelina®) cut following a specified path is made in the web through flame cutting. The two resulting T-sections are realigned and welded

together. The final beam is typically 40 to 50% deeper with a 50% increase in section modulus/load carrying capacity and a 125% increase in inertia/stiffness relative to the parent section, all this for no increase in weight.

The flame cutting process can be customised to meet specific project needs, and is automatically adjusted to allow for the effects of pre-cambering when specified.

Cuts are performed in such a way that waste material is limited and weld areas are as efficient as possible. Welds are visually inspected or, on request, can be inspected according to the project owner's or customer's specifications.

Figure 6: Fabrication process for cellular beams

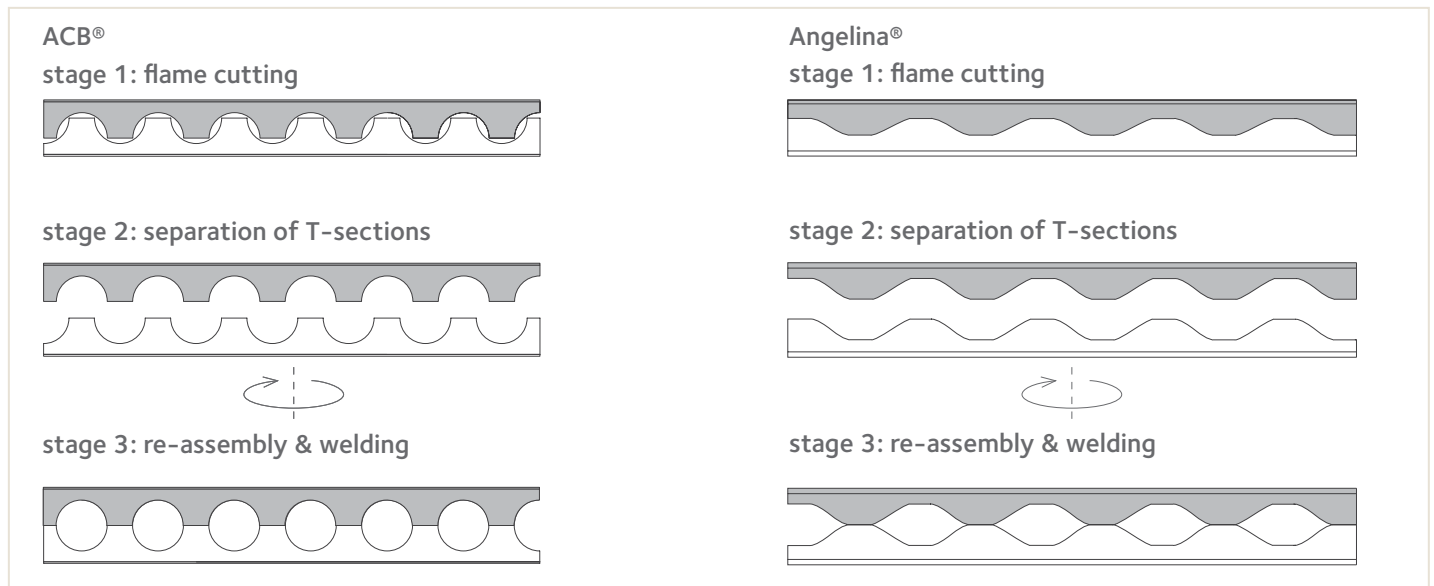



Figure 7: Fabrication of Angelina® beams

3.1. Determination of size and spacing of openings



For a given section, there are endless combinations of opening sizes and spacing that can be implemented. Items that are typically considered when determining the appropriate layout for a project follow:

- To maintain aesthetic proportions, the ratio between the opening height (a_0), spacing (e) and final height (H_t) should be kept in a specific range. The range is generally governed by the application in which the system will be used (Fig. 8).

In some cases, opening height (a_0) is governed by the size of components of the MEP or other building systems.

- To ensure structural integrity and efficiency, customisation of the upper and lower T-sections can and should be considered.
- To simplify fabrication, wherever possible, the designer should consider adjusting the geometry of the openings to design out unnecessary end infills.

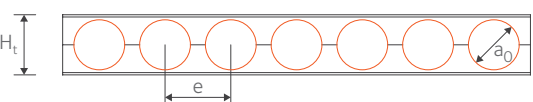
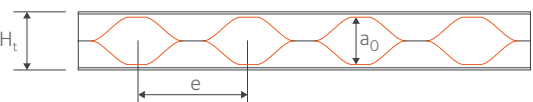
Figure 8: Size and spacing of openings

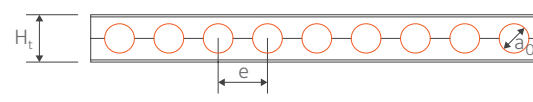
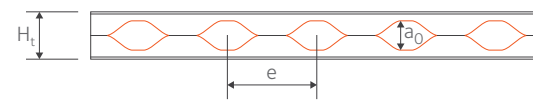
<p>Applications: Roofing Footbridges Wide-span purlins</p> <p>Objective: Optimisation of the height/weight ratio</p> <p>Starting section (height h)</p>  <p>Design type 1 (ACB® and Angelina®)</p>   <p>Diameter or height $a_0 = 1,0$ to $1,3 h$ Spacing $e = 1,1$ to $1,3 a_0$ Final height $H_t = 1,4$ to $1,6 h$ Common steel grades: S355</p>	<p>Applications: Floors Parking structures Offshore structures</p> <p>Objective: Optimisation of load/weight ratio</p> <p>Starting section (height h)</p>  <p>Design type 2 (ACB® and Angelina®)</p>   <p>Diameter or height $a_0 = 0,8$ to $1,1 h$ Spacing $e = 1,2$ to $1,7 a_0$ Final height $H_t = 1,3$ to $1,4 h$ Common steel grades: S355, S460, HISTAR® 460</p>
---	---



Cellular beams spanning 25 meters and featuring important camber

3.2. Customisation of cellular beams

3.2.1. Curving or cambering

Where required for architectural or serviceability reasons (i.e. create positive roof slopes for rainwater run off or to manage dead load deflection, cellular beams can be curved and cambered. Achieved during fabrication, the top and bottom tee's are curved/cambered prior to assembly and welding into the final state (Fig. 9).

A minimum camber of 15 mm is recommended, and in order to avoid any risk of inverted installation, cambers will be clearly marked on each beam before they leave the fabrication facility.

Figure 9: Example of a curved ACB® beam

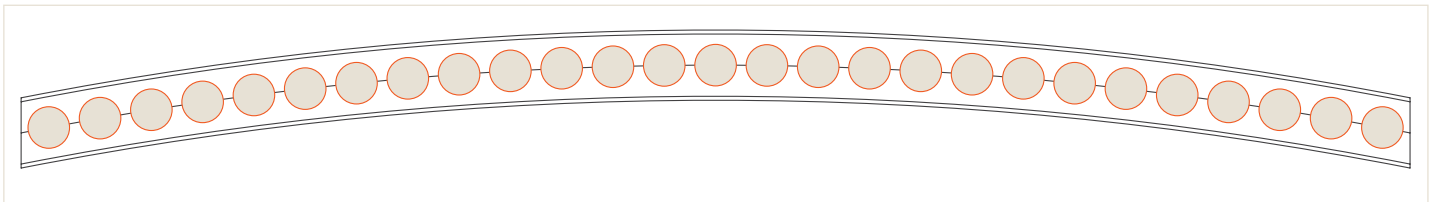

3.2.2. Tapered profiles

Tapered sections are easily produced by inclining the cut and rotating one of the T-sections though 180° before welding (Fig. 10).

Tapered sections are particularly efficient solutions for long cantilevers, such as stadium stands; continuous beams, such as footbridges or portal frame rafters .

Figure 10: Tapered ACB® beams

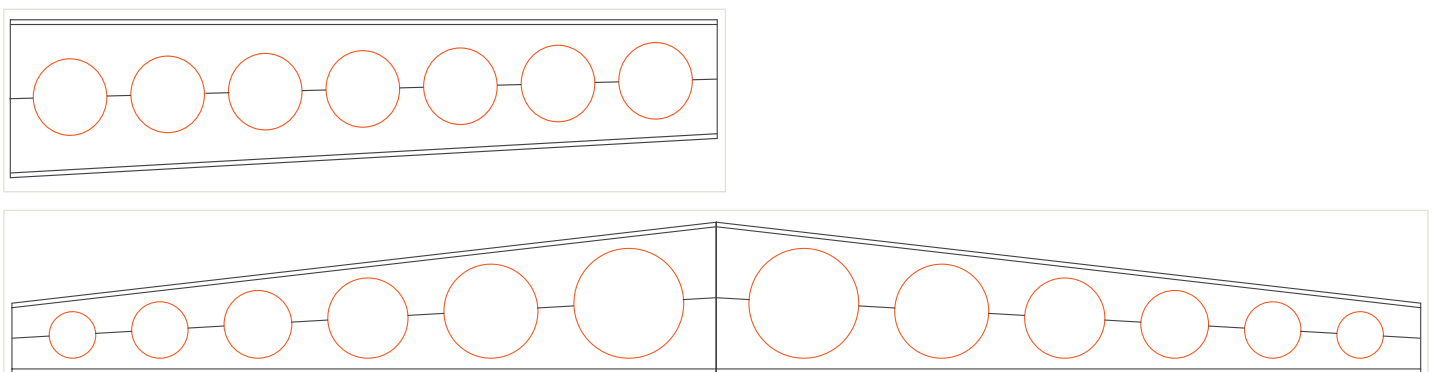
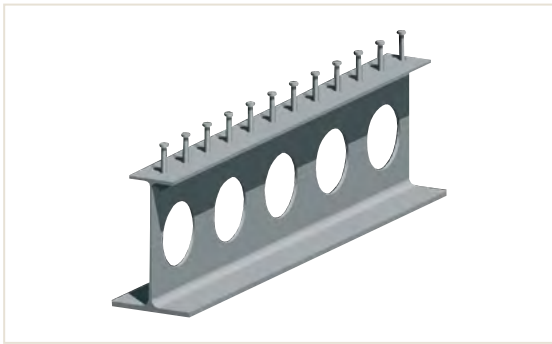

Figure 11: Asymmetrical ACB® beam



3.2.3. Asymmetrical sections

Top and bottom T from differing profiles, or even steel grades, can be welded together to produce asymmetric profiles (Fig. 11). Asymmetric beams are adapted to composite design, having the ideal distribution of mass resulting in the lightest possible section. For such systems, it is common to have a heavier bottom T as it is subject to tension from global bending. The top T's primary function is to support the wet concrete at the construction stage, and so this is typically 30% lighter than the bottom T.

3.2.4. Elongated openings

It is possible to remove a web-post between two adjacent cells to create an elongated opening. Where possible these openings should be positioned near the center of the beam (Fig.12), where shear forces are typically lowest. In cases where an elongated opening must be located near the supports, it may be necessary to stiffen the openings (Fig.13b).

Figure 12: Elongated opening

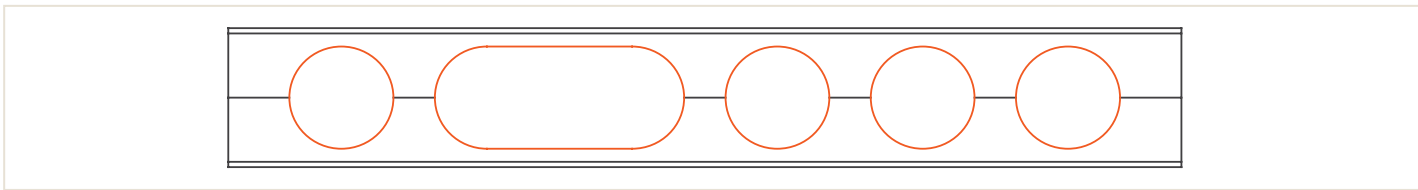

3.2.5. Infill of openings

In order to support high shear forces (i.e. in close proximity to supports or point loads) or for fire safety reasons, it may be necessary to infill cells (Fig. 13a). This is done by inserting a custom-cut steel plate into the opening and welding it from both sides of the web. The thickness of the plate and its fillet weld, generally limited to 4mm, are optimised according to local stresses.

Figure 13a: Filled openings

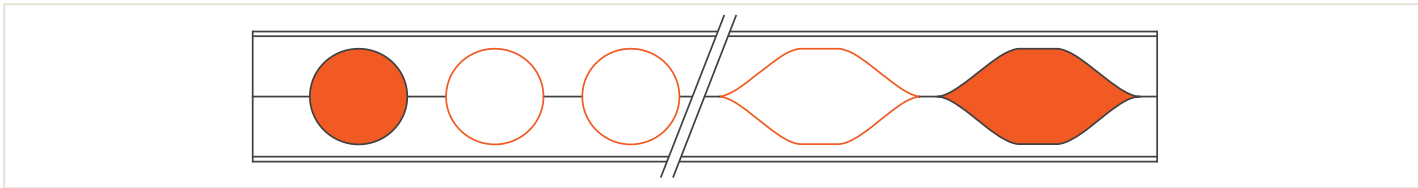

3.2.6. Reinforced openings

In cases where infilling is not permitted for architectural reasons or when elongated openings are necessary close to supports, a hoop stiffener welded around the opening can be used to increase rigidity of the opening (Fig. 13b).

Figure 13b: Reinforced opening

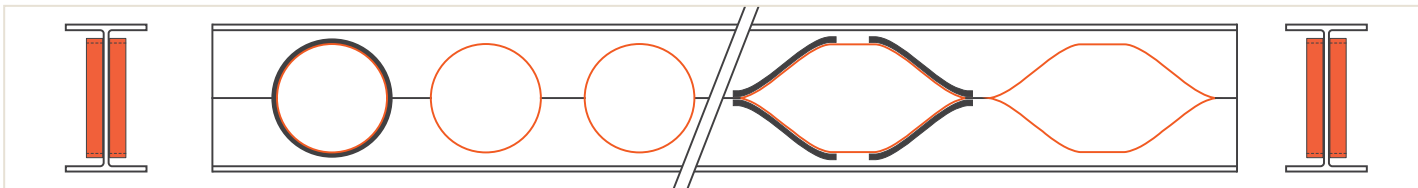

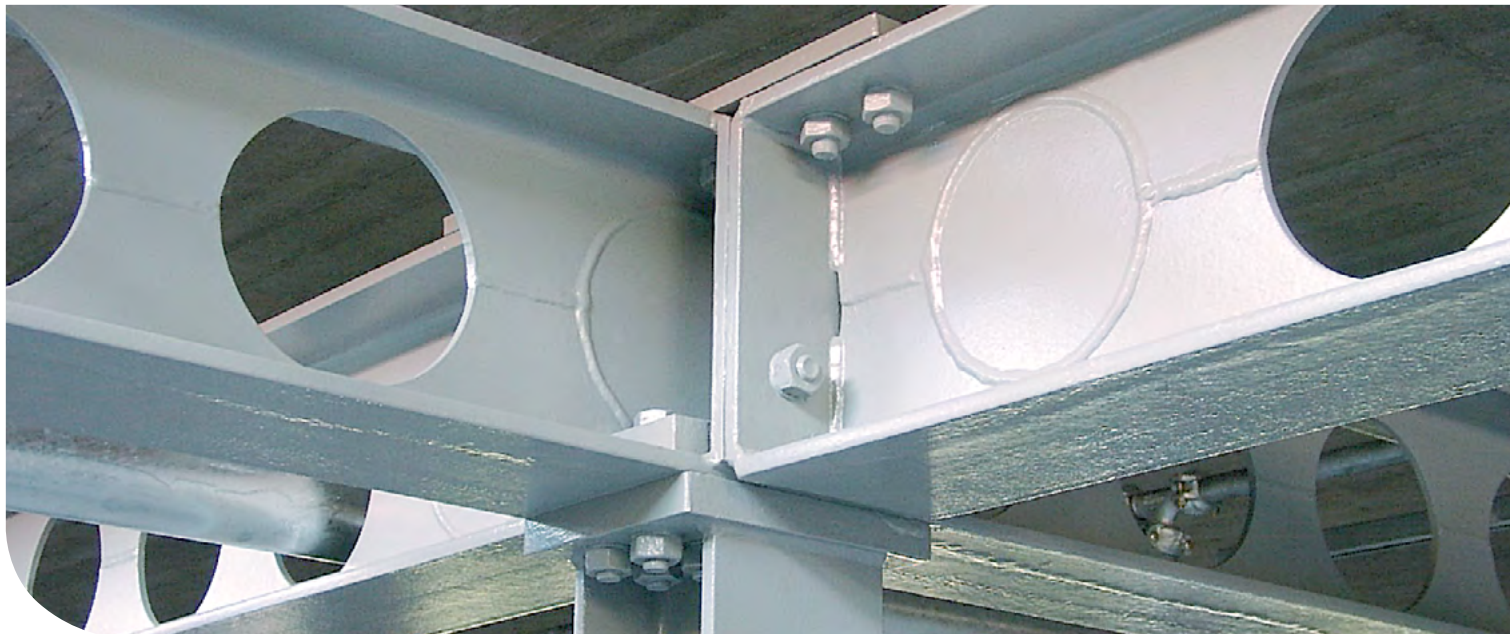

ACB® beam featuring filled openings at support

3.2.7. Web reinforcement

Serviceability limit states require sufficient stiffness to reduce deflection and minimise vibrations. Cellular beams can efficiently meet these needs by optimising the distribution of steel throughout the profile.

At times, optimisation may result in a risk of buckling at one or two web posts near the supports. In order to fortify the section, the following options can be considered:

- selection of a heavier section
- use of a higher steel grade, which would increase the load bearing capacity of the web posts
- infilling of openings, though this can result in less flexibility to accommodate building services
- stiffening of openings, which would maintain flexibility for accommodating building services.

Figure 14: Stiffened web post

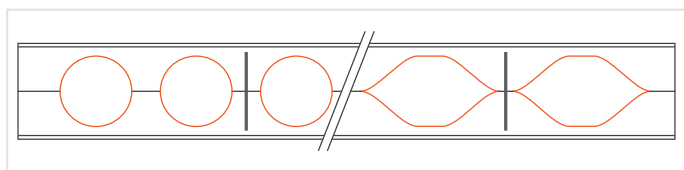

Alternatively, testing has shown that a rigid plate, welded to the web post (Fig. 14), is an effective solution to reinforce the beam web. Two part hoops can also be used (Fig. 15).

Figure 15: Stiffener welded around the opening

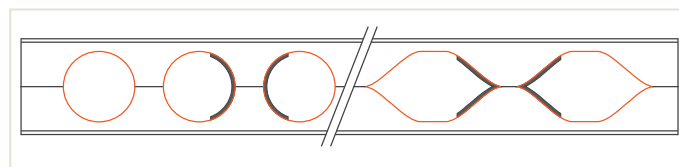

3.2.8. Supporting concentrated loads

In order to avoid plastic deformation of elements within the cross-section, which can occur when concentrated loads are applied to the beam, stiffeners or infills should be considered wherever concentrated loads are expected.

3.3. Welding standards

At ArcelorMittal's fabrication facility, welders are qualified in accordance to the European standard EN 287-1 for MAG 135 and MAG 136 processes. Typically, butt welding is used for the web-post welds to cellular beams. A full penetration weld is not usually required.

A series of tests has been carried out to validate the model used in the software ACB+ and ANGELINA. This model can be used to calculate the required weld penetration to resist the applied stresses.



3.4. Fabrication options

Select examples of fabrication options are shown in Figure 16.

Figure 16: Fabrication options

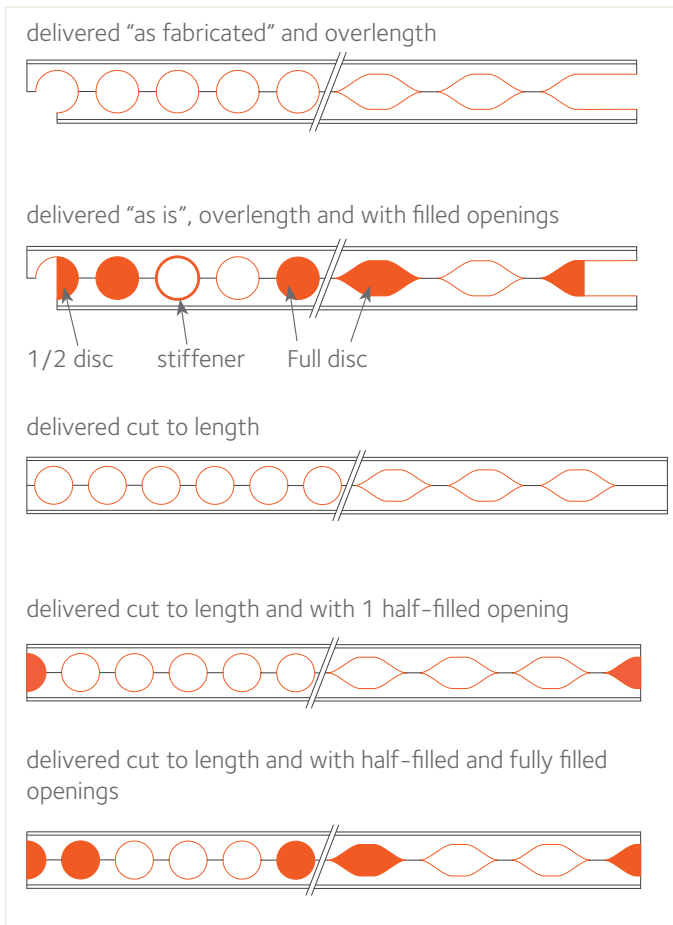

3.5. Optimisation of the openings

When designing the framework, special care should be given to the positions of the openings in order to avoid unnecessary filling (Fig. 17).

- The first step is to optimise the beam from a structural point of view.
- The second step is to adjust the spacing between openings so as to have a complete web post at the ends of the beam.

Figure 17: Optimisation of openings layout

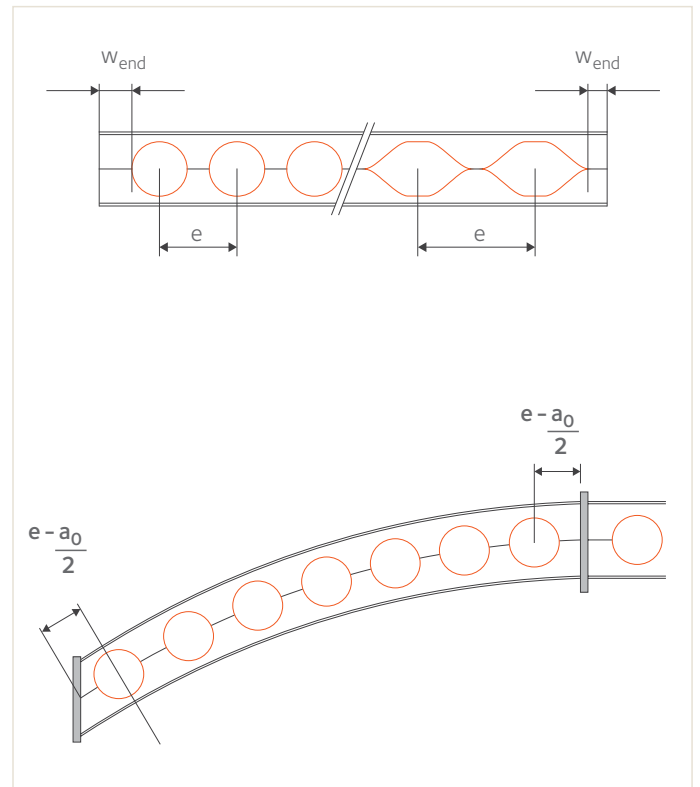

3.6. Splicing of cellular beams

As with standard beam sections, it will sometimes be required to splice cellular beams. In such cases, the designer should take splice locations into account when setting out the openings. If necessary, to maintain load paths within the system, it is possible to infill or partially infill one or two openings. Partial filling is an easy and economical solution (Fig. 18).

3.7. Curving of beams

The curving of cellular beams is easily carried out as part of the fabrication process.

It's often required for the following reasons:

- architectural requirements for the roofing system
- compensating for the load dead deflection

Other forms of curving or cambering can be offered on request, the minimum camber being 15mm.

3.8. Coordinating fabrication considerations with design requirements

In order to achieve the most economical fabrication of cellular beams, requirements of the cutting process, such as minimum distance between web/flange root and the edge of the openings or minimum radius of curved beams, are included in the ACB+ and ANGELINA software (see section 9. Predesign software).

Figure 18: Partially filled openings at splice locations

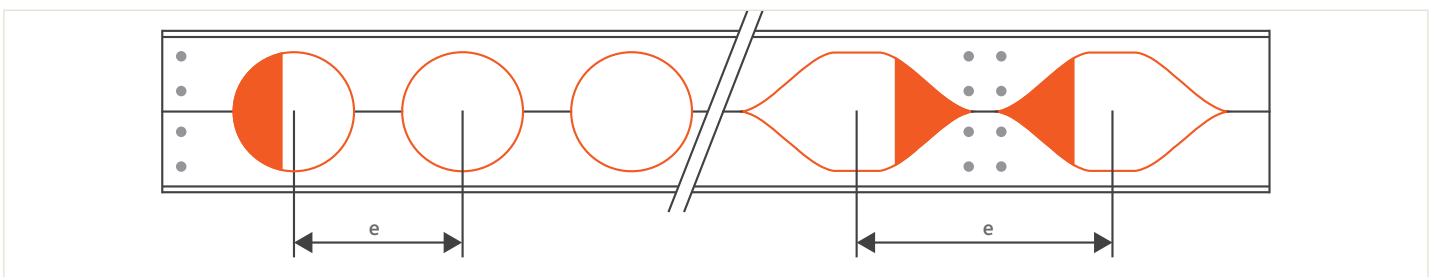

4. Tolerances of ACB[®] and Angelina[®] beams

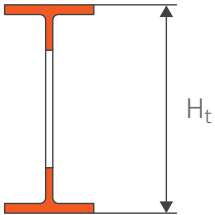
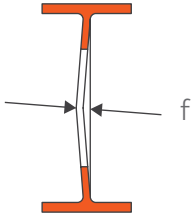
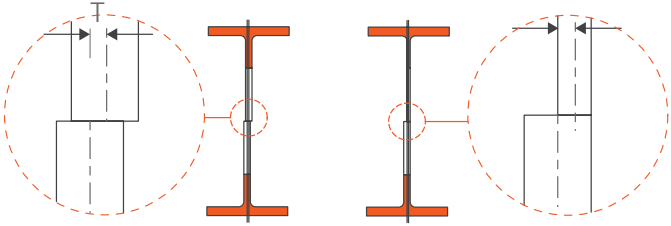
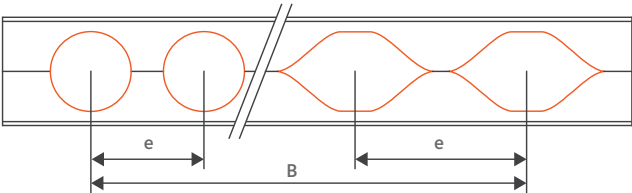
<p>Final height:</p> <p style="text-align: right;">H_t</p> <p style="text-align: right;">$H_t < 600$</p> <p style="text-align: right;">$600 \leq H_t < 800$</p> <p style="text-align: right;">$H_t \geq 800$</p>	<p style="text-align: center;">$+ 3 / - 5 \text{ mm}$</p> <p style="text-align: center;">$+ 4 / - 6 \text{ mm}$</p> <p style="text-align: center;">$+ 5 / - 7 \text{ mm}$</p>	
<p>Bending of web:</p> <p style="text-align: right;">f</p> <p style="text-align: right;">$H_t < 600$</p> <p style="text-align: right;">$H_t \geq 600$</p>	<p style="text-align: center;">$f \leq 4 \text{ mm}$</p> <p style="text-align: center;">$f \leq 0,01 H_t$</p>	
<p>Misalignment of T-sections: (between axis of upper section and axis of lower section)</p> <p style="text-align: right;">T</p>	<p style="text-align: center;">$T \leq 2 \text{ mm}$</p>	 <p style="text-align: center;">Symmetrical section Hybrid section</p>
<p>Spacing:</p> <p style="text-align: right;">e</p> <p>Distance from first to last opening:</p> <p style="text-align: right;">B</p>	<p style="text-align: center;">$\pm 0,01 e$</p> <p style="text-align: center;">$\pm 0,02 e$</p>	

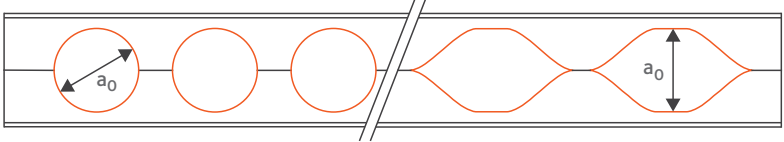
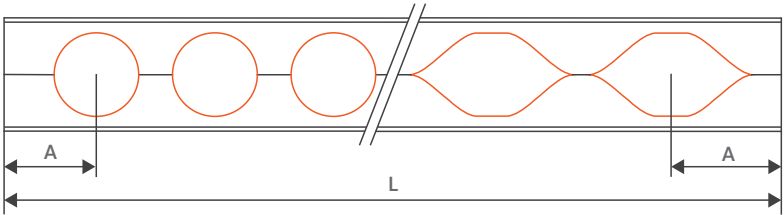
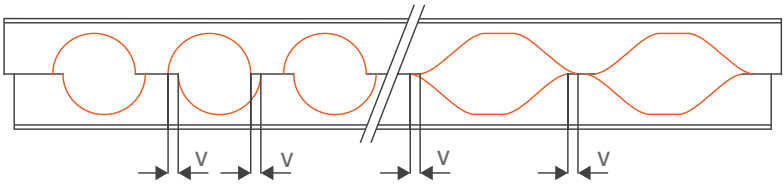
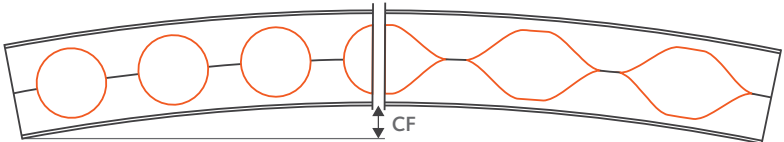
<p>Diameter/height: a_0</p>	<p>+ 5 / - 2 mm</p>	
<p>Length: L</p> <p>Distance of 1st opening from end: A</p>	<p>+/- 2mm</p> <p>+/- 0,02 e</p>	
<p>Offset of web posts: V</p> <p>Example:</p>	<p>$V \leq 0,03 \% L$</p> <p>if L = 10 000 mm $V \leq 3\text{mm}$</p>	
<p>Camber: CF</p>	<p>+/- 0,05 CF</p> <p>CF min. 5mm</p>	



Industrial site BOBST in Mex (CH) / MP INGENIEURS CONSEILS SA – Crisler (CH) / Architects:
RUCHTER & DAHL / ROCHA – Lausanne (CH) / Engineers: MP INGENIEURS CONSEILS SA – Crisler

5. Beams with large web openings in roof and non-composite floor applications

When used in roof applications, ACB® and Angelina® beams are typically symmetrical sections; comprising of a top and bottom T cut from the same hot-rolled parent shape (Fig. 19). Determination of the appropriate parent section and final height is typically based on opening size and spacing requirements. Alternatively, when final height and opening size are known, the necessary spacing and appropriate parent shape can be selected.

Figure 19: Configuration of a cellular beam

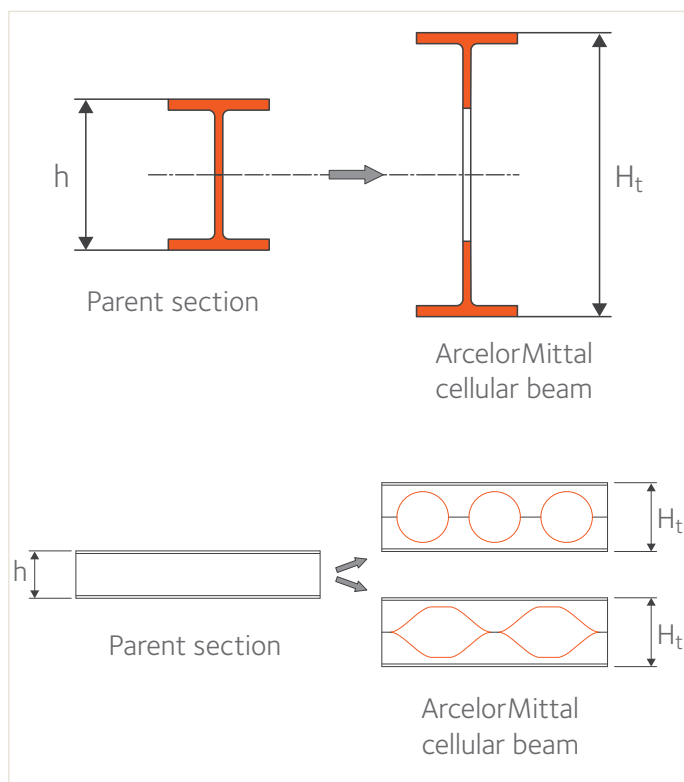

Architects and engineers have a lot of freedom in the choice of opening size and spacing. From these values, the starting section can be determined and the final height of the cellular beam can be deduced.

The process can also be reversed: from a required final height and opening dimensions, the designer can easily determine the starting section required to satisfy this configuration.

5.1. Design recommendations

As for the rolled sections, it is essential to base the design of a project in cellular beams on criteria and limits that make the best use of the performance offered by this type of element.

5.1.1. Establishing the overall height of the cellular beam

The overall height, H_t , of the cellular beam is determined as a function of the following (Fig. 20):

- beam span (L)
- beam spacing (B)
- strength requirements, i.e. dead load and live load demands
- serviceability requirements, i.e. deformation and vibration limits.

Figure 20: Use of beams in structure

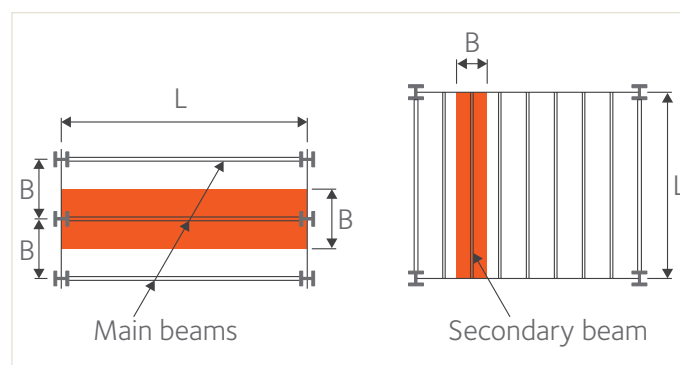

When used in standard roof applications, cellular beams can typically have span/depth ratios ranging from 20 to 40 depending on support conditions (Fig. 21). For initial design assumptions, a value of 30 is generally used to determine the section properties of secondary beams and fixed beams of frames. Through iteration, a more efficient solution can be determined.

For non-composite floor beams, the span/depth ratio typically varies from 10 to 20. For normal service loads, an intermediate value of 15 can be used as a starting point for design.

Figure 21: Height of cellular beam as a function of the span

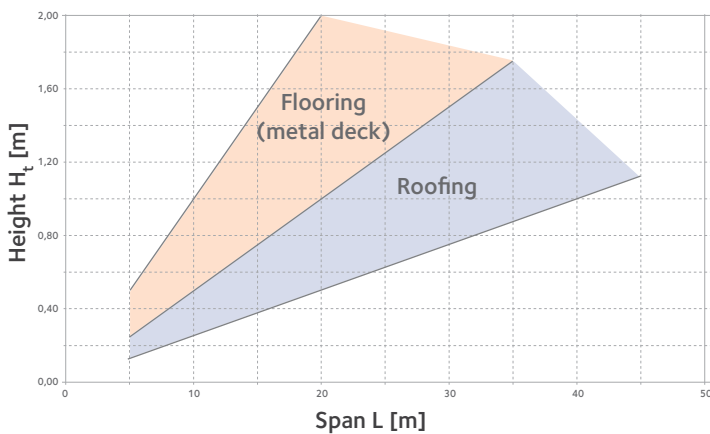

5.1.2. Determining layout of web openings

Layout of web openings is typically governed by architectural desires (transparency and light dispersion) and functional requirements (distribution of building services through the penetrations).

However, there are geometric limits to be respected for good mechanical behaviour of the cellular beam. These limits apply to:

1) Opening size (Fig. 22):

- with a_0 , s and w values a function of the finished beam
- with a_0 , a and c values a function of the parent section.

Figure 22: Geometric limits on openings in ACB® and Angelina® beams

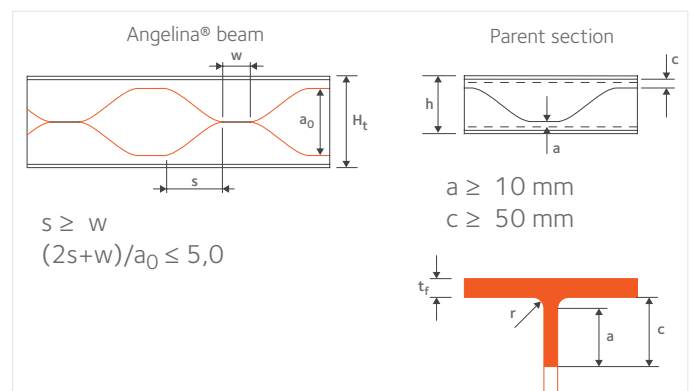
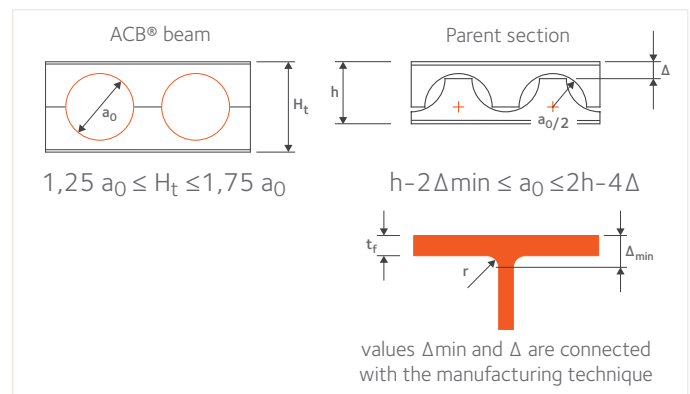



P. de Coubertin gymnasium (Bourges, France ; Arches Études)

2) Spacing of the openings (Fig. 23):

When determining spacing between web openings, both strength and fabrication requirements should be taken into account. From a strength perspective, a minimum spacing is established to avoid localised failure from insufficient bearing at the web posts between openings. Similarly, this minimum ensures that enough material is present to provide the welded connection between the top and bottom T at the fabrication facility. A maximum spacing is established to achieve the most efficient fabrication of the cellular beam by minimising the length of weld required. This maximum also guarantees that the beam depth will increase when the openings are cut and the section is shifted for welding. If the distance between web penetrations is large and the opening size is small, for example, the final beam would not gain much, if any height, or improved efficiency in design.

To assess potential local instabilities within the section, the following should be considered:

- capacity of the section at the web posts, taking account of:
 - vertical shear forces
 - moment forces
 - shear-moment interaction
 - horizontal shear forces
- shear buckling resistance
- capacity of the section at the web openings, taking account of:
 - shear force resistance
 - moment and axial force interaction
 - moment, shear and axial force interaction
- resistance to Lateral Torsional Buckling

Figure 23: Geometric limits for spacing between openings

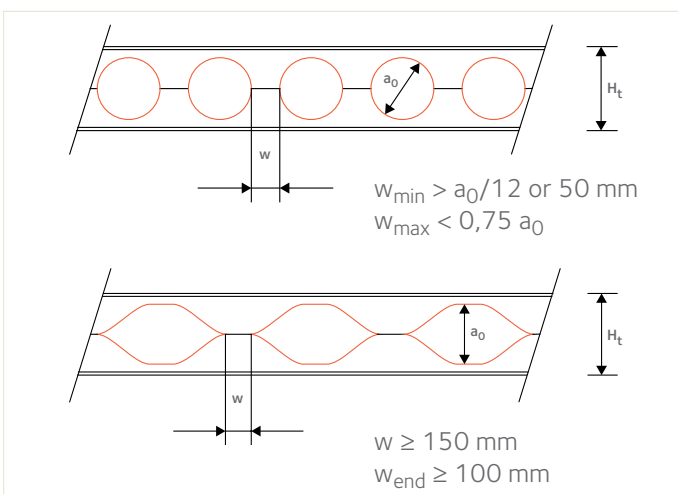

When assessing the behaviour of the overall section, the following should be considered:

- vertical deflection
For the calculation of the overall deflection of a beam, the beam is divided in elementary panels of two types: “Plain” and “Opening” panels, for which the calculation method differs. The contribution of the “Plain” zones to the deflection of the beam is derived from classical formula. The calculation method for the deflection of the “Opening” zone is a sum of values of elementary effects due to axial, shear and bending deflection. The deflection of the beam is obtained as the sum of the contributions of each elementary zone.
- eigen frequency.

5.2. Design checks

The global design of cellular beams must meet both Ultimate Limit States and Serviceability Limit States requirements like any other structural member. However, there are additional secondary forces around the cells that must be considered to.

ACB+ and ANGELINA software (see section 9. Predesign software) enable users to verify cellular beam configurations based on the previously discussed design considerations. In addition, using the predesign tables in section 10. Predesign charts of cellular beams, designers can select a cellular beam section for a given load and span.



6. Beams with large web openings in composite floor systems

The use of ACB® and Angelina® beams in composite floors (Fig. 24) allow designers to optimise both floor zone and span. Spans achievable with cellular beams can reach 30m, making them a great solution for commercial offices where typical floor spans are 18m.

The efficient distribution of mass in these beams means that vibration and comfort criteria can be achieved with less. Beam spacing is between 2,70m and 4,05m in combination with traditional composite decks and between 5,40m and 8,10m in combination with additive deck Cofraplus 220 or composite floor Cofradal 200/260.

6.1. Design recommendations

6.1.1. Establishing the overall height of the cellular beam

In addition to the criteria defined in section 5. Cellular beams in roofing and flooring (metal deck) applications, when using cellular beams in composite design the following considerations should be made:

1) beam span

Beam span (L) will typically vary between 8 and 30m depending on application. When the design assumes simple supports, the concrete slab will be in compression throughout the span.

Figure 24a: Angelina® beams in composite floor systems



Figure 24b: ACB® beams in composite floor systems

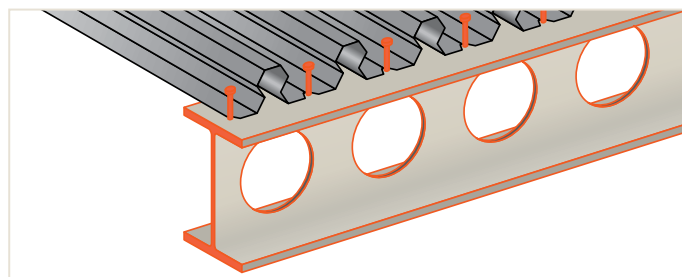

In situations where the beam is continuous over intermediate supports, the concrete will experience tensile forces and cracking at the supports.

2) beam spacing

Beam spacing (B) of the framing depends on floor type:

- For steel decking
 - B = 2,5 to 3m without propping
 - B = 3 to 5m with propping
- For Cofraplus 220 additive decking
 - B = 3 to 5m without propping
 - B = 5 to 8m with propping
- For precast concrete units
 - B = 2,7 to 7m without proppingSpans of 5 to 7m can also be achieved without propping using ArcelorMittal Cofradal 200/260 flooring (metal deck)".
- Allowed structural floor zone corresponding to the height of the composite beam H_t plus the slab thickness. The beams should be spaced according to the following ratios:
 - $L/H_t > 20$: B = 2,5 to 3 meters
 - $L/H_t < 15$: B = 3 to 5 meters



Géric Thoronville, Architectes Ertim/Design-Team

Figure 26: Composite floor beam

3) serviceability requirements

For floor structures, Serviceability Limit States often govern the design. Vibration tolerances are generally specified by acceptance classes [A to E] and compared to the predicted response that the floor system will have due to vibrations induced from loading (i.e. human traffic) expected from the intended use of the building.

For more information on considering serviceability requirements in your design, please refer to the document titled “Design Guide for Floor Vibrations”, which is available in the Library section of sections.arcelormittal.com.

6.1.2. Determining layout of web openings

Layout of web openings is typically governed by functional requirements (distribution of building services). In office buildings, for example, a height between 250 and 350mm is adequate in most cases.

Minimum and maximum height and spacing values, as they relate to the hot-rolled parent section, are governed by the same rules given in section 5. Beams with web openings in roof and non-composite floor applications.

Figure 25: Height, H_t , of floor beam as a function of span

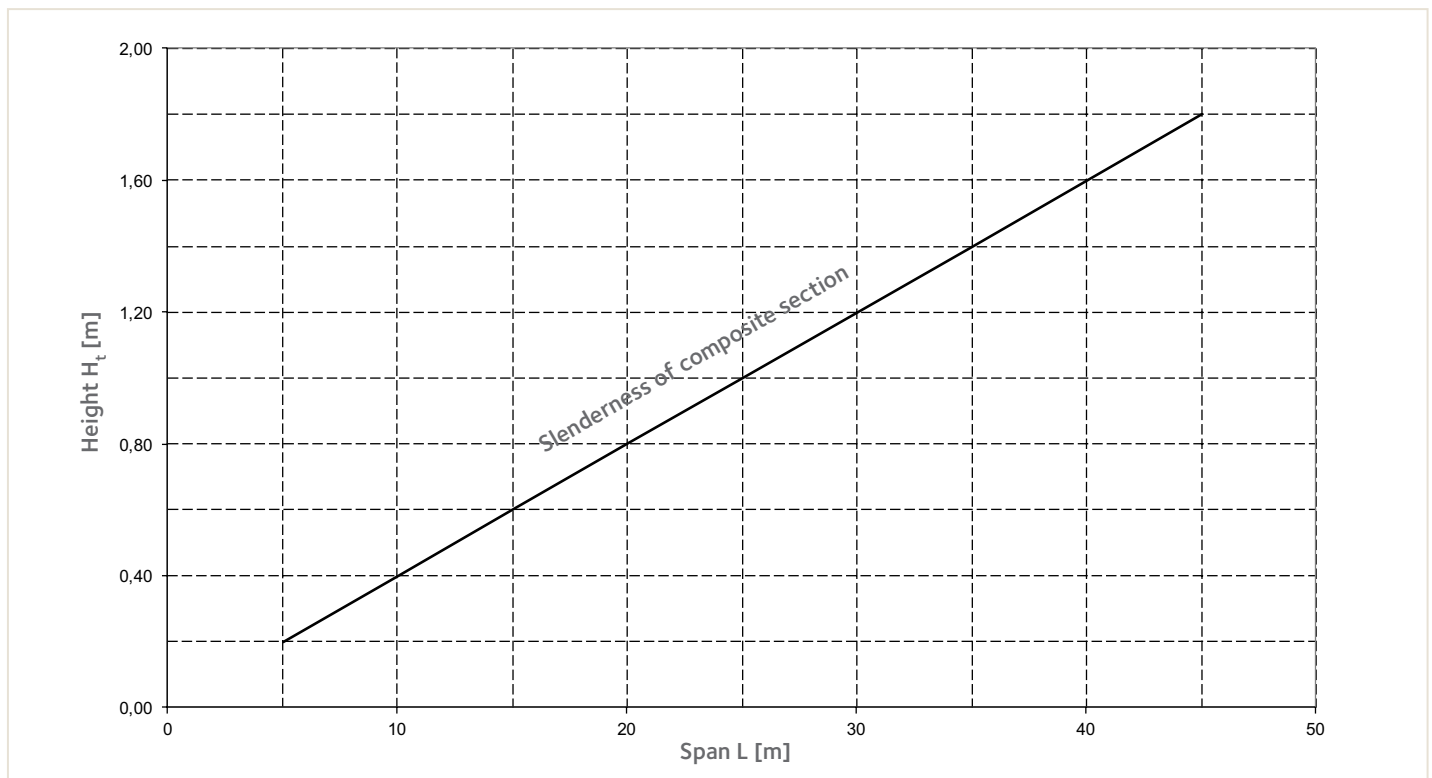

6.2. Design checks

In addition to the design checks defined in section 5. Beams with web openings in roof and non-composite floor applications, cellular beams used in composite construction would require verification of the following:

- section capacity during construction (i.e. without contribution of the concrete slab and dependent on propping conditions)
- capacity of shear studs, ensuring that they can help achieve the desired composite action
- bending moment capacity of the composite section
- vertical deflection within permitted serviceability limits, taking into account concrete shrinkage.

ACB+ and ANGELINA software (see section 9. Predesign software) enable users to size cellular beams based on the previously discussed design considerations.

Alternatively, there are predesign tables in section 10. Cellular beams predesign charts offer a quick answer based on standard solutions for composite floor applications.

A mid-span splice connection
on a tapered cellular roof beam

Simply supported tapered cellular beams
can be used to reduce overall building height.



7. Stability under fire conditions

The inherent fire resistance of ACB® and Angelina® beams under ISO fire is usually 15 to 20 minutes. The R30 requirement may be reached by a moderate overdesign, using for example a higher grade (S460). In more severe cases, the fire resistance may be obtained by application of spray or intumescent coating. In the case of composite floors with secondary beams, tensile membrane action of the floor may be activated and passive protection limited to steel members connected to columns. This strategy leads to a significantly lower number of beams to protect but necessitates a specific calculation. MACS+ software was developed for this purpose.

Fire protection can be reduced or removed by applying the Natural Fire Safety Concept. This takes into consideration the real fire conditions (fire load, ventilation by openings, active measures), and calculation methods are provided in the EN 1991-1-2 and have been implemented into OZone software. In a similar way passive protection can be calculated and applied to beams with no web openings, as a function of the fire requirement and A/V factor related to the failure mode, and following the guidance provided by the product manufacturer. The thickness of fire protection may also be calculated more accurately on the basis of the critical temperature. Predesign software ACB+ and Angelina provide these critical temperatures.

Figure 27: Protection by spraying on ACB® beam

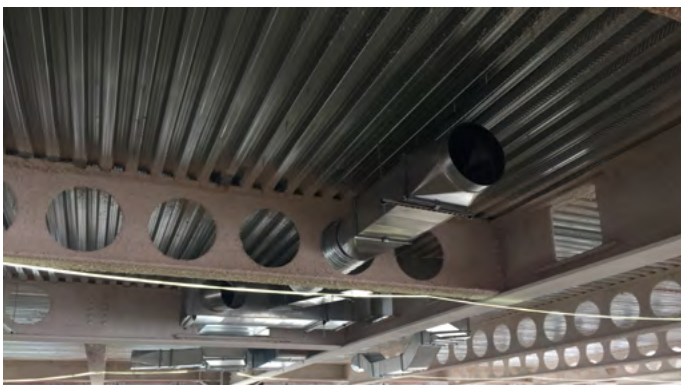

For cellular beams, the surface area to be protected against fire is essentially equivalent to the surface area of the hot-rolled parent structural shape. Values of painting surface per unit length (AL, m²/m) and painting surface per unit mass (AG, m²/t) are indicated for individual sections in the tables of the ArcelorMittal Europe Sales Programme Sections and Mechant bars, which is available in the Products & Services section of sections.arcelormittal.com.

Furthermore, ArcelorMittal's Technical Advisory Department uses the SAFIR software with a module especially developed for the design by numerical simulation of cellular beams.

In office buildings, the most suitable passive protection is spray if the beams are not visible. The composite floor typically does not need any protection.

For Angelina® beams, it may be necessary to increase the corresponding thickness of the coating by 2 to 3 cm around the opening to ensure sound protection of the sharp contour.

To accommodate ductwork, a 3 to 5 cm difference between opening dimensions and duct size is recommended. This tolerance can help prevent damage of the fire protection around the openings during installation of the services. In some cases, no additional anti-corrosion treatment is necessary if the product is sprayed onto the raw steel surface.

In the case of visible floor or roof beams intumescent paint provides fire resistance without influencing the aesthetic of the structure.

8. ACB® and Angelina® beams: a solution for sustainable constructions

Through changes in regulations and the use of environmental assessment methods, such as BREEAM and LEED, the operational impacts of buildings have reduced significantly over recent years. However, these assessment methods don't fully address a building embodied carbon or the sometimes-complex interdependent relationship that exists between operational and embodied impacts. The only true way to deliver a low/zero impact building is through the use of life cycle analysis that considers both embodied and operational impacts – something recognised in ArcelorMittal's Steligen® concept. Steligen® is a comprehensive, science-based solution offering stakeholders throughout the architectural, engineering and construction community the opportunity to optimise every aspect of a building. This radical new concept will facilitate the next generation of high performance buildings and construction techniques, and create a more sustainable life-cycle for buildings. In Life Cycle Assessment (LCA) studies ACB® and Angelina® beams have been shown to offer net positive contributions to both operational and embodied impacts.

ACB® and Angelina® beams offer the following benefits:

1. Clear spans

With an optimum span range of 12 to 18m (although larger spans are possible) ACB® and Angelina® beams provide high value column free space that can be easily adapted to accommodate changing patterns of use. This is aligned

with circular economy principles, encouraging and promoting longer life in service.

2. Service integration

The regular array of large web openings allows MEP services to easily be passed through the beams. When compared to alternative solutions where structure and services are kept separate, this approach allows overall floor zones and therefore total building height to be reduced. A consequential benefit is a reduction in the area of the external envelope and its embodied impacts, and internal air volumes that are minimised resulting in operational energy reductions associated with space heating/cooling.

3. Highly efficient asymmetric section

In clear span applications where slab and beam are acting as one composite unit, an asymmetric profile can be used. This provides the optimum distribution of mass and the lightest possible section for a given span.

4. Low impact material

ACB® and Angelina® beams are manufactured from ArcelorMittal's HISTAR® 355 and HISTAR® 460 steel sections. These profiles are manufactured from scrap material using the electric arc furnace (EAF) process with embodied impacts that are significantly lower than conventional steels.

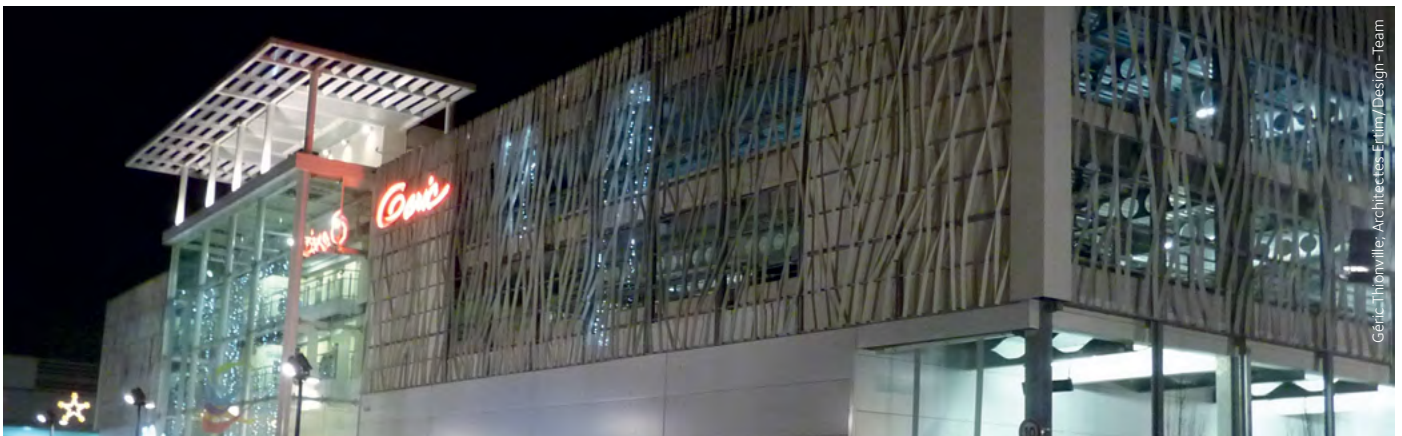

Additional level through ACB® and Angelina® beams

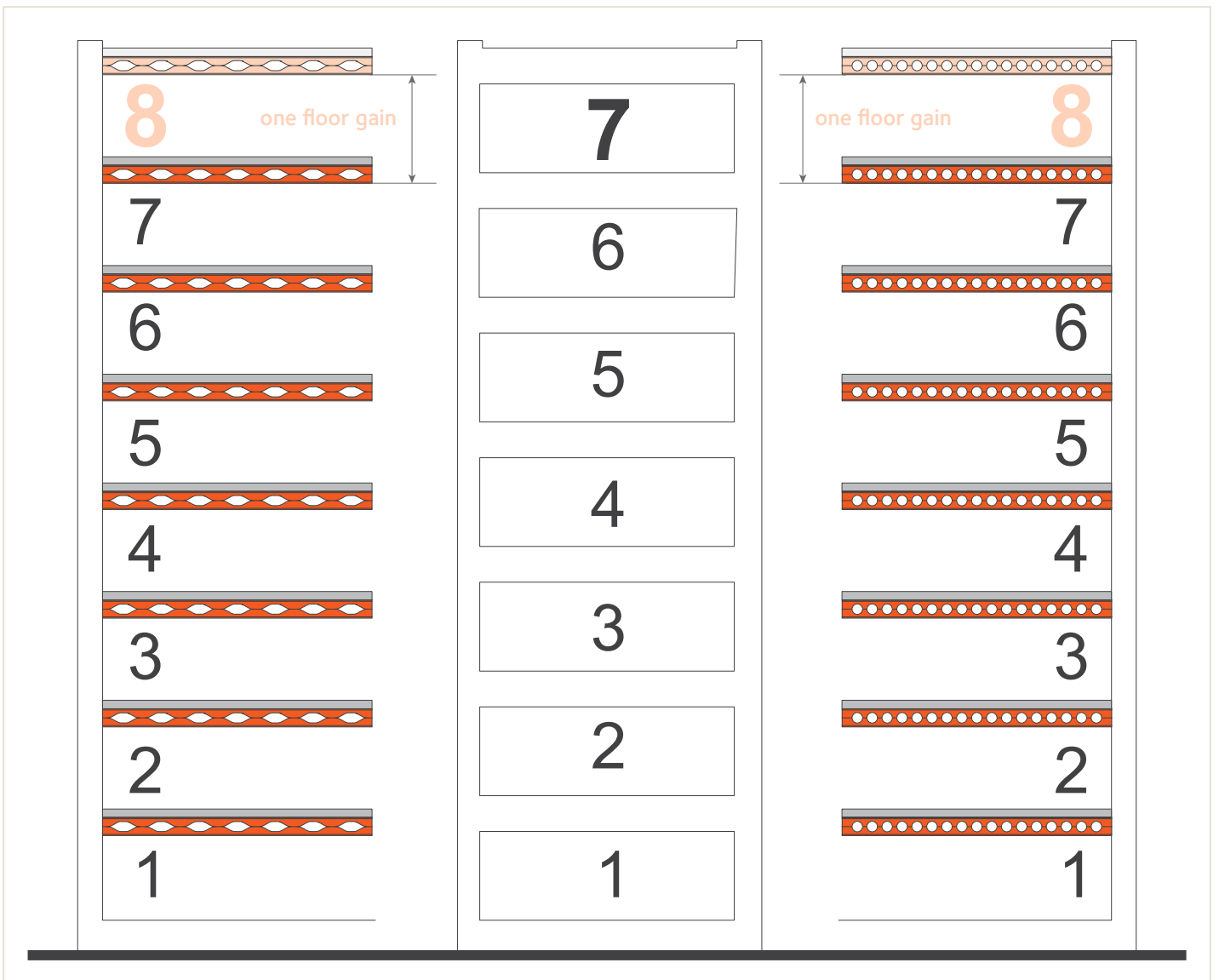

Angelina® offering the 8th floor for the same height

Traditional concrete building

ACB® offering the 8th floor for the same height



9. Predesign software

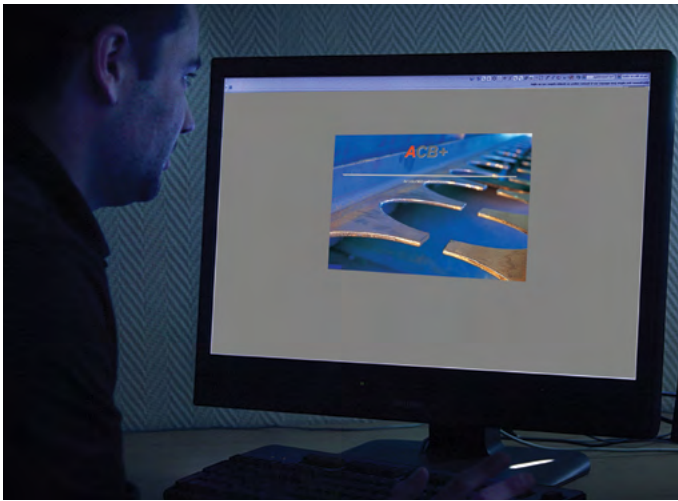

ACB+ software enables the configuration of a variety of ACB® beam solutions:

- single span beams
 - straight composite beam
 - straight steel beam
- tapered steel beam with single slope or double slopes
- curved steel beam
- cantilever steel beams
 - straight steel beam
 - tapered steel beam.



ANGELINA software enables the design of a variety of Angelina® beam solutions:

- single span beams
 - straight composite beam
 - straight steel beam.

The software is available in English, French, German and Spanish languages.



Both software packages perform capacity checks based on Ultimate Limit State – verifying cross section capacity, local buckling, and lateral torsional buckling – according to Eurocode 3 and Eurocode 4 (EN 1993 and EN 1994) design requirements. In addition, the software calculates deflections and natural frequencies based on Serviceability Limit State requirements.

The software includes the full list of hot-rolled sections from the ArcelorMittal catalogue. This free software can be downloaded from sections.arcelormittal.com.

10. Predesign charts of beams with large web openings

ArcelorMittal has developed predesign charts to enable engineers to quickly determine initial section sizes and web opening layouts based on the loading conditions of their projects. To refine and customise their solutions to more specifically meet project needs, ACB+ and ANGELINA software provide an opportunity to explore an unlimited selection of design options, including varying the number and size of openings and changing span lengths. Adding partial or complete infills and exploring the use of web stiffeners is also recommended to increase capacity.

The predesign charts have been developed for non-composite and composite beams in steel grades S355, S460 and HISTAR® 460. Using these charts helps to quickly identify the maximum span length for 5 different categories of cellular beam solutions. The charts assume a partial safety factor, γ_{M1} , of 1.0 according to EN 1993-1-1.

ACB® for roofing (charts 1 to 3)

This chart has been developed for steel grade S355 with starting sections considered to be IPE for light loads, HEA for medium loads, HEB for heavy loads.

Chart notes:

- An approximate spacing, e , of $1.25 * a_0$ is assumed
- Design assumes a limit is set on final height
- Deflection limit is set at $L/180$.

ACB® for flooring (metal deck) (charts 4 to 9)

This chart has been developed for steel grades S355 and S460 with starting sections considered to be IPE for light loads, HEB for medium loads, HEM for heavy loads.

Chart notes:

- An approximate spacing, e , of $1.5 * a_0$ is assumed
- Design assumes a limit is set on final height
- Deflection limit is set at $L/180$.

Composite ACB® (charts 10 to 15)

This chart has been developed for steel grades S355 and S460 and normal concrete class C30/37.

The starting sections considered to be IPE for light loads, HEA for medium loads, HEB for heavy loads.

Chart notes:

- An approximate spacing, e , of $1.5 * a_0$ is assumed
- Design assumes a limit is set on final height
- Composite slab assumes to be 120mm thick with trapezoidal steel deck own weight of $2,12 \text{ kN/m}^2$ (212 kg/m^2)
- Slab span set to 3 m perpendicular to the beam
- A full shear connection between the slab and the section is assumed
- The beam is assumed to be propped and laterally braced during construction
- Deflection limit is set at $L/180$.

Angelina® for roofing and for flooring (metal deck) (charts 16 to 18)

This chart has been developed for steel grades S355 and S460 with starting sections considered to be IPE for light loads and HEA for medium loads.

Chart notes:

- Web post length, w , is set to 200mm or 250mm
- Deflection limit is set at $L/200$.

Composite Angelina® (charts 19 to 27)

This chart has been developed for steel grades S355 and HISTAR® 460 and normal concrete class C30/37.

Figure 29: Design load

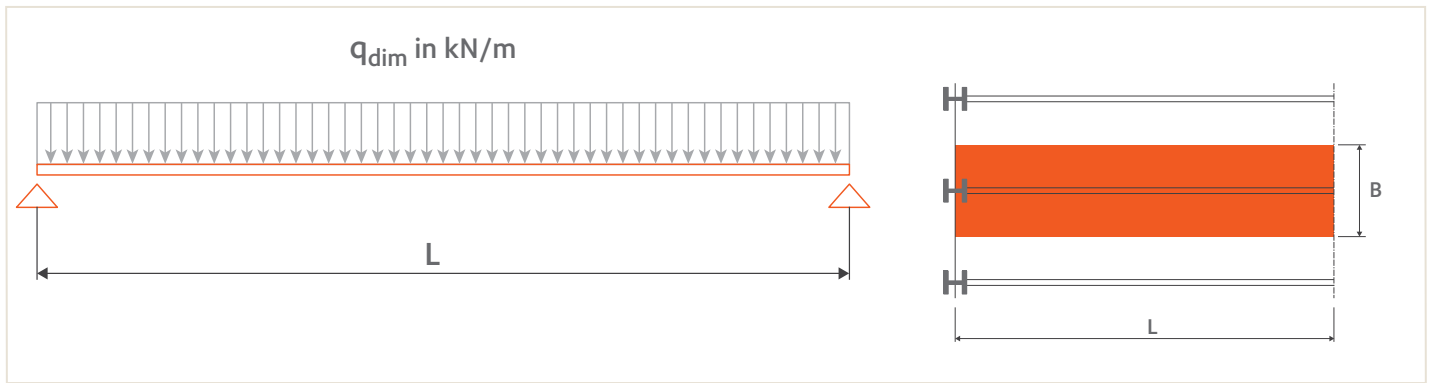

Chart notes:

- The openings proportions are fixed such that $a_0 = s$
- Web post length w is set to 200mm or 250mm
- For charts with cast-in-place concrete, composite slab assumed to be 120mm thick with trapezoidal steel deck own weight of 2,12 kN/m² (212 kg/m²), and slab span set to 3 m perpendicular to the beam
- For charts with prefabricated slab element, Cofradal 200, slab assumed to have an own weight of 2,00 kN/m², and slab span set to 6 m perpendicular to the beam
- When Cofradal 200 is used, the effective width is assumed to be 1m and the available height for shear resistance is assumed to be 20cm
- A full shear connection between the slab and the section is assumed
- The beam is assumed to be shored and laterally braced during construction
- Deflection limit is set to $L/200$ and vertical deflection of the composite section takes into account shrinkage of the concrete.

Design load

The design load, q_{dim} , in kN/m, is project specific and should be compared with the ultimate load, q_u , given in the charts.

This ultimate load takes into account all criteria required for Ultimate Limit States (ULS) and deflection at Serviceability Limit States (SLS). To compare design load directly with the ultimate load, the following ULS load combination should be used:

$$q_{dim} = (1,35 G + 1,5 Q) B$$

where :

- B = beam spacing [m],
- G = permanent load per square meter [kN/m²],
- Q = variable load per square meter [kN/m²].

Using the predesign charts

There are three possible procedures:

Case 1, where design load, q_{dim} , and the span length, L , are known:

Design load, q_{dim} , is taken equal to ultimate load, q_u , and the intersection of the line representing q_u and L can be located on the chart. The design section that will have adequate capacity to meet project needs can be identified by the curve located to the right of the point of intersection. Using the curve name (i.e. A, B, C, etc.), the user can enter the table below the chart and determine the corresponding section size that was used in creating the curve. The table also indicates the properties of the web openings that were used in creating the curve. Once the section is identified, the web opening size and layout should be checked against any functional requirements specific to the project.

Case 2, where the section size is known along with the span length, L :

Using the table corresponding to the chart in question, the appropriate design curve (A, B, C, etc.) can be identified. By following this curve to its intersection with the necessary span length, the section capacity can be found. The capacity, q_u , should be compared to the design load to verify that $q_{dim} \leq q_u$.

Case 3, where the section size is known along with the design load, q_{dim} :

In this case, q_{dim} is taken equal to q_u and the design curve is determined from the section size and the table corresponding with the appropriate predesign chart. The intersection of the line representing q_u and the design curve can be located on the chart. This intersection corresponds to the permissible span length that will ensure desired capacity of the section is achieved.

Example of Angelina® predesign

Beam A to be designed as Angelina® beam for a composite floor with a span length of $L = 16$ m and a spacing of $B = 3$ m.

For architectural reasons, the final height of the floor is limited to 700 mm (this allows the maximum height of the Angelina® section to be $H_t = 580$ mm) with a 120 mm slab.

Design parameters :

- Slab thickness = 12 cm
- Concrete class; C30/37
- Steel deck with 60 mm rib height.

Loading criteria:

$$q_{dim} = (1,35 G + 1,5 Q) B$$

with

$$G = g_{Angelina} + g_{slab} + g_2$$

The weight of the Angelina® beam is initially assumed to be 1 kN/m, equivalent to $g_{Angelina} = 0,33 \text{ kN/m}^2$.

For a 12 cm thick slab on steel decking, the weight $g_{slab} = 2,12 \text{ kN/m}^2$

$g_2 =$ additional permanent load = $1,0 \text{ kN/m}^2$

$Q =$ variable load, value chosen for this example: 6 kN/m^2

The design load, q_{dim} , is:

$$q_{dim} = (1,35 \times (2,12 + 0,33 + 1) + 1,5 \times 6) \times 3 = 41 \text{ kN/m}$$

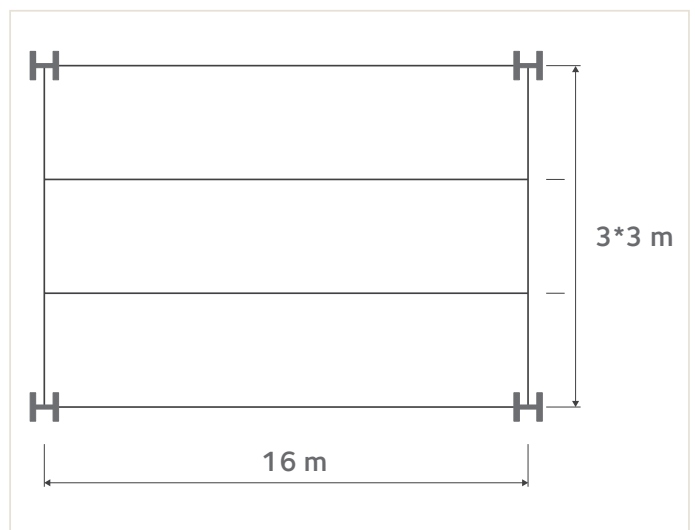

Using the predesign charts for sizing as a function of load and span, the required section can be determined (case 1). Given that a maximum height of the beam is imposed at 580mm, the solution should come from wide flange section range. The choice of chart falls on the HEB range in S355.

Using $q_{dim} = q_u$ and length to enter the predesign charts and table identifies curve B as a potential solution.

The required section is HE 320 B with $H_t = 487,5$ mm and $a_0 = 335$ mm.

With the section is known, one can enter the values in the ANGELINA software in order to refine the results and carry out the various ULS and SLS checks.

Chart: Composite Angelina® based on HEB, S355 with COFRAPLUS 60

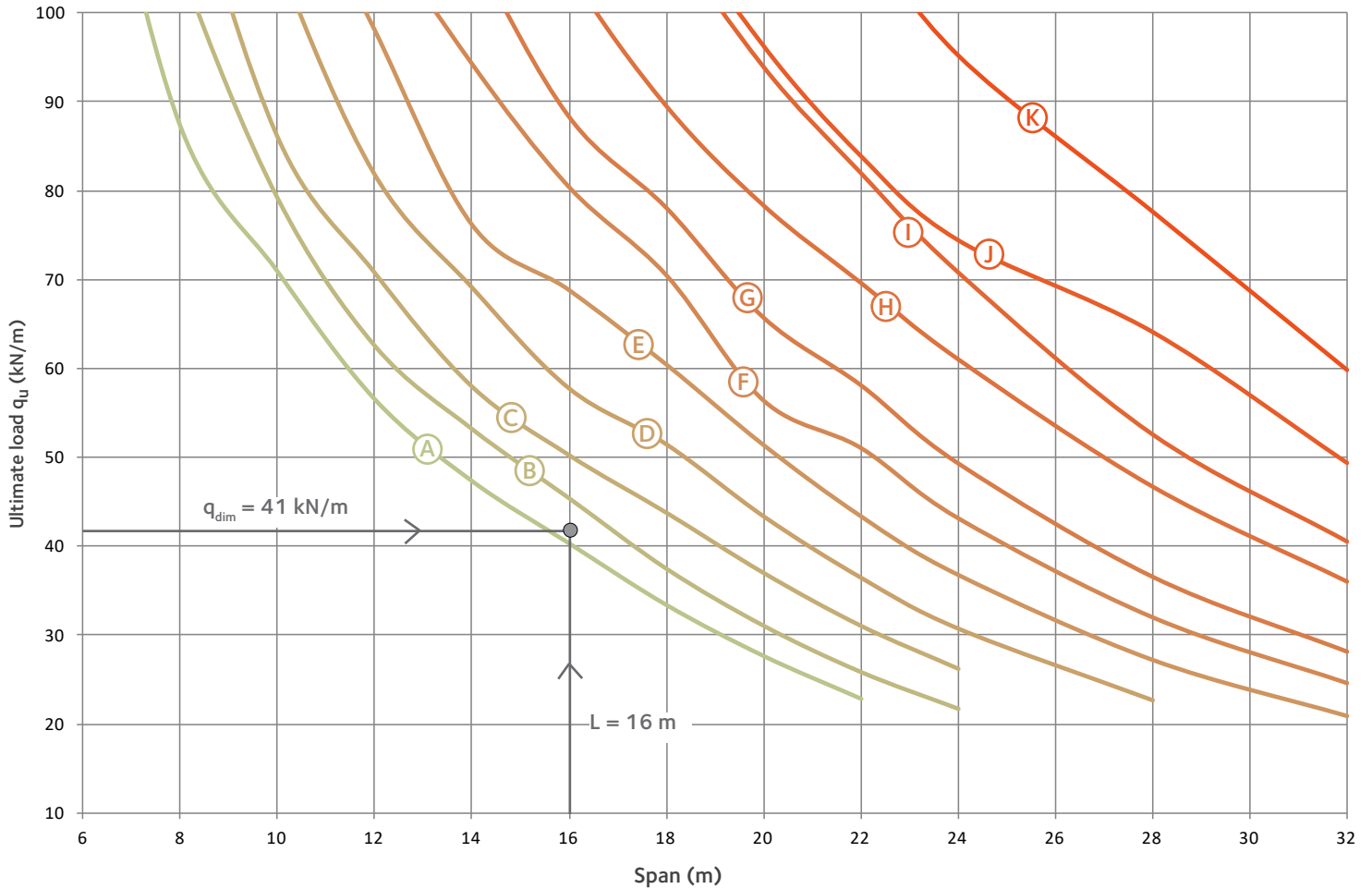

Sections	Dimensions (mm)					Ultimate load q_u (kN/m) according to the span (m)												
	a_o	w	s	e	H_t	6	8	10	12	14	16	18	20	22	24	28	32	
(A)	HE 300 B	315	250	315	1130	457,5	129,3	87,5	71,0	56,6	47,4	40,4	33,5	27,7	22,9			
(B)	HE 320 B	335	250	335	1170	487,5	138,5	105,6	79,3	62,6	53,3	45,4	37,5	31,1	25,9	21,7		
(C)	HE 360 B	380	300	380	1360	550		120,6	86,2	70,8	58,0	50,3	43,8	37,0	31,0	26,2		
(D)	HE 400 B	420	300	420	1440	610		137,9	106,4	81,9	69,1	57,7	51,4	43,3	36,4	30,7		
(E)	HE 450 B	475	300	475	1550	687,5		151,5	120,9	98,1	76,2	68,8	60,4	51,3	43,3	36,7		
(F)	HE 500 B	525	300	525	1650	762,5			132,4	111,1	94,3	80,4	70,5	56,4	51,1	43,2		
(G)	HE 550 B	580	300	580	1760	840				130,6	107,7	88,4	78,1	65,7	58,1	49,4	12,6	
(H)	HE 650 B	680	300	680	1960	990				153,2	125,4	104,8	89,5	78,3	69,6	61,0	16,2	11,0
(I)	HE 700 B	730	300	730	2060	1065					154,9	130,7	109,8	94,0	82,0	70,9	20,2	13,7
(J)	HE 800 B	780	300	780	2160	1190						136,3	112,6	96,3	83,9	74,4	25,2	17,1
(K)	HE 900 B	830	350	830	2360	1315							155,9	128,6	109,9	95,2	31,9	21,8

1.1. Predesign charts for ACB®

Chart 1: Non-composite ACB® based on IPE, S355, $e=1.25 a_0$

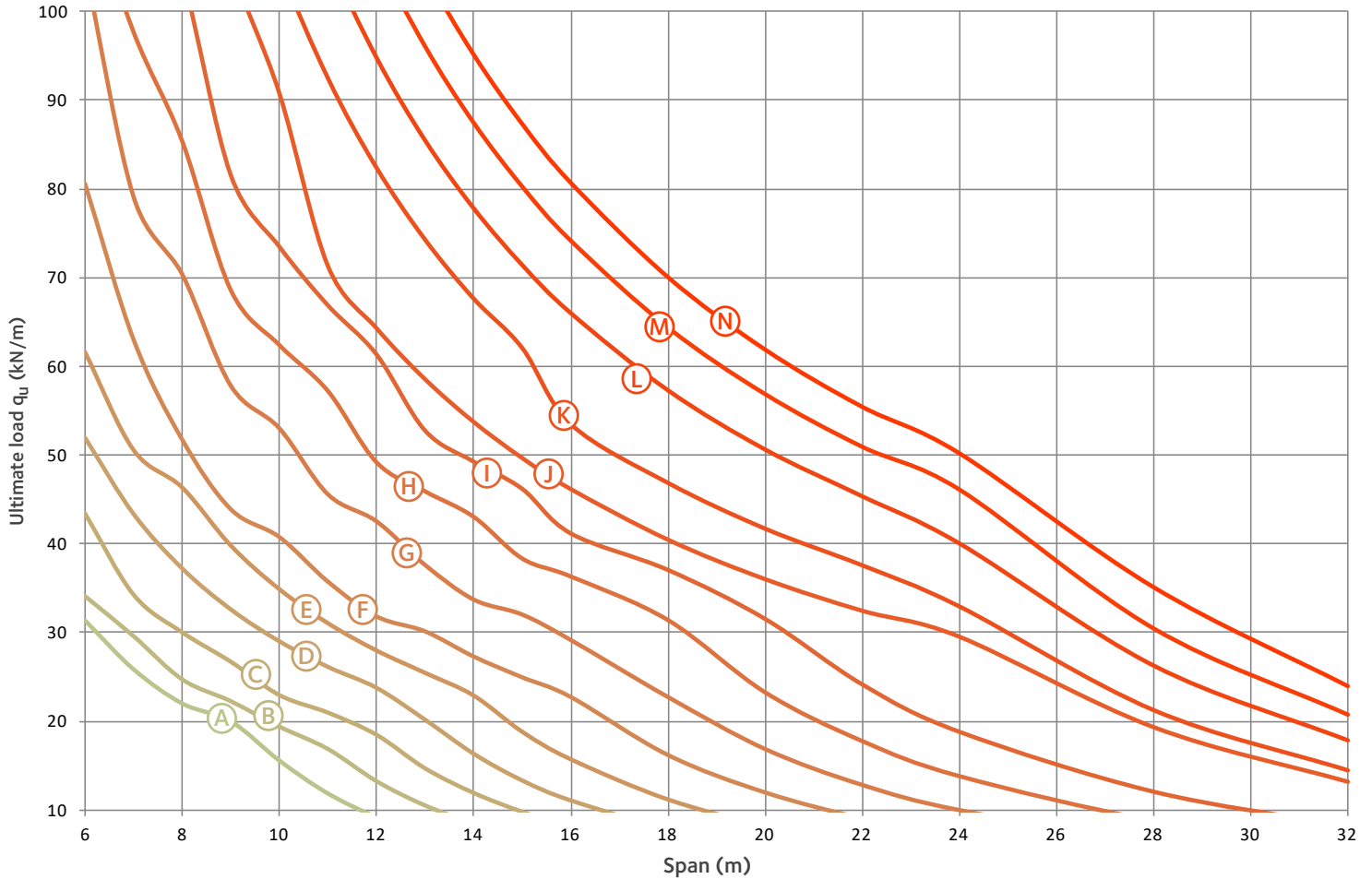

Sections	Dimensions (mm)				Ultimate load q_u (kN/m) according to the span (m)																	
	a_0	w	e	H_t	6	7	8	9	10	11	12	13	14	15	16	18	20	22	24	28	32	
(A)	IPE 270	285	75	360	399	31,4	25,9	22,1	20,1	15,6	11,9											
(B)	IPE 300	315	75	390	445	34,2	29,6	24,8	22,3	19,4	16,9	13,2	10,5									
(C)	IPE 330	345	85	430	489	43,4	34,2	30,0	26,7	22,9	20,9	18,4	14,6	11,9								
(D)	IPE 360	380	100	480	535	52,0	43,4	37,3	32,7	29,1	26,2	23,8	20,2	16,4	13,4	11,1						
(E)	IPE 400	420	110	530	594	61,6	50,5	46,3	39,8	34,9	31,0	28,0	25,4	22,9	18,8	15,7	11,2	8,2				
(F)	IPE 450	475	115	590	672	80,6	63,0	51,7	43,9	40,8	35,7	31,8	30,1	27,3	24,9	22,7	16,2	12,0				
(G)	IPE 500	525	135	660	745		79,2	70,5	57,9	53,1	45,6	42,6	37,6	33,7	32,0	29,2	22,7	16,9	12,8			
(H)	IPE 550	580	150	730	822			97,7	85,4	68,6	62,4	57,2	49,2	45,9	43,1	38,4	36,3	31,4	23,3	17,8	13,8	
(I)	IPE 600	630	160	790	896				81,6	73,5	66,9	61,3	52,7	49,2	46,2	41,1	37,0	31,5	24,1	18,8	12,0	
(J)	IPE 750 x 134	785	196,2	981,2	1122					90,8	71,3	64,3	58,5	53,7	49,6	46,1	40,4	36,0	32,4	29,5	19,3	13,1
(K)	IPE 750 x 147	790	197,5	987,5	1127						92,5	82,4	74,3	67,6	62,1	53,5	46,9	41,7	37,6	32,9	21,2	14,4
(L)	IPE 750 x 173	795	198,7	993,7	1139							94,8	85,5	77,8	71,4	66,0	57,3	50,6	45,3	40,0	26,3	17,8
(M)	IPE 750 x 196	800	200	1000	1149								96,1	87,5	80,3	74,2	64,4	56,9	51,0	46,2	30,5	20,8
(N)	IPE 750 x 220	805	201,2	1006,2	1160									95,2	87,3	80,7	70,1	61,9	55,4	50,2	35,1	24,0

Chart 2: Non-composite ACB[®] based on HEA, S355, e=1.25 a₀

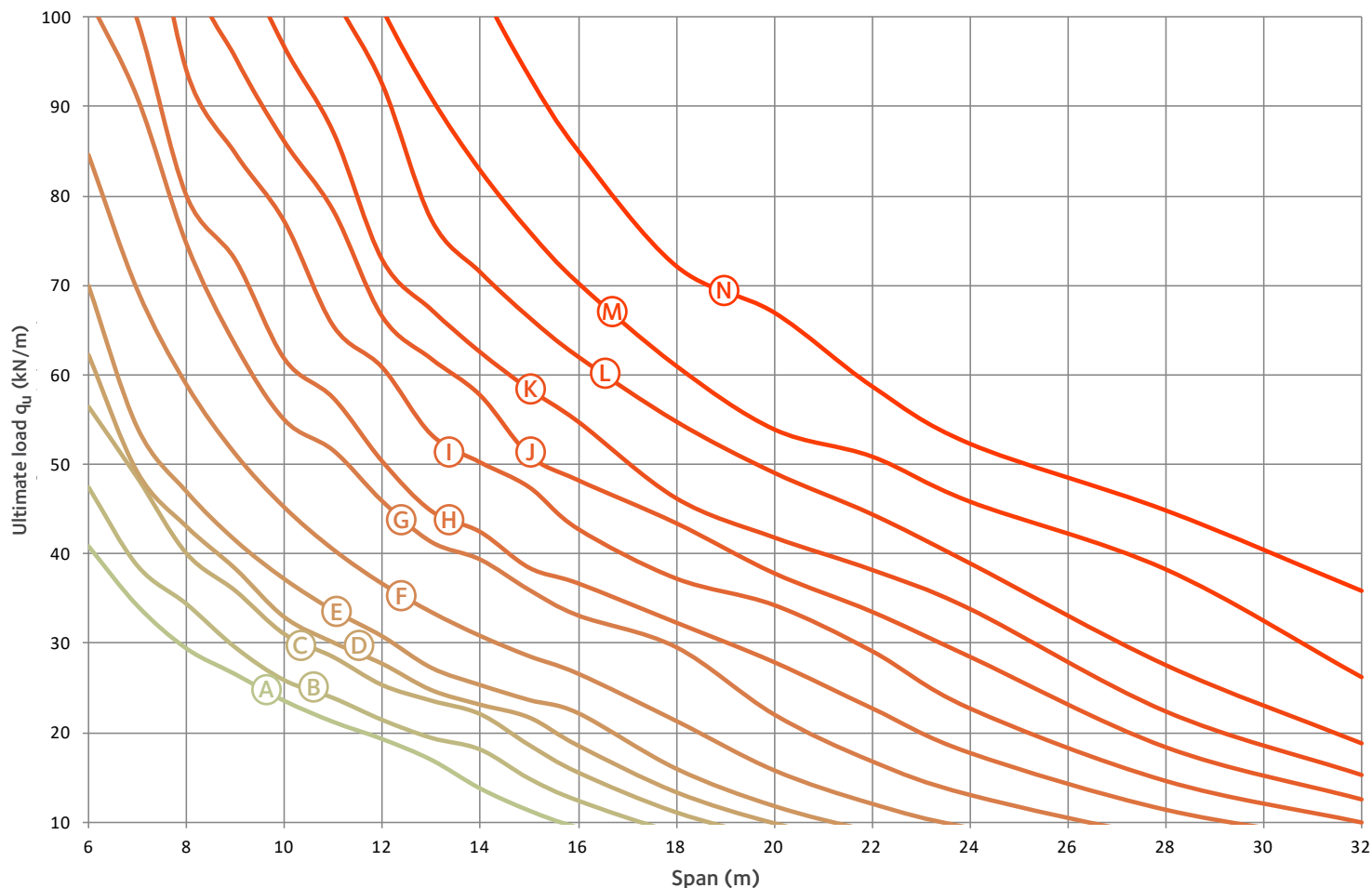

Sections	Dimensions (mm)				Ultimate load q _u (kN/m) according to the span (m)																	
	a ₀	w	e	H _t	6	7	8	9	10	11	12	13	14	15	16	18	20	22	24	28	32	
Ⓐ	HE 280 A	285	75	360	399	40,9	34,2	29,4	26,6	23,6	21,2	19,3	17,0	13,8	11,3							
Ⓑ	HE 300 A	305	75	380	430	47,4	38,7	34,4	29,5	25,9	23,9	21,4	19,5	18,1	14,9	12,4						
Ⓒ	HE 320 A	325	85	410	459	56,4	48,4	40,0	35,8	31,0	28,4	25,3	23,6	22,0	18,6	15,5	11,1					
Ⓓ	HE 340 A	345	85	430	489	62,3	49,1	43,1	38,3	32,9	30,1	27,7	24,7	23,1	21,7	18,5	13,3					
Ⓔ	HE 360 A	370	90	460	521	70,0	54,1	46,9	41,5	37,2	33,6	30,7	27,2	25,3	23,6	22,2	15,9	11,8				
Ⓕ	HE 400 A	410	100	510	581	84,6	69,5	58,9	51,2	45,2	40,5	36,7	33,5	30,9	28,6	26,6	21,4	15,8	12,1			
Ⓖ	HE 450 A	460	120	580	654		91,0	74,7	63,4	55,0	51,6	45,9	41,4	39,4	36,0	33,2	29,6	22,1	16,9	13,1		
Ⓗ	HE 500 A	515	125	640	732		99,6	80,1	72,9	61,8	57,5	50,4	44,8	42,5	38,5	36,7	32,4	27,9	22,8	17,8	11,4	
Ⓘ	HE 550 A	565	145	710	805			94,0	84,7	77,1	65,4	60,8	53,3	50,2	47,4	42,7	37,2	34,2	29,1	22,7	14,6	
Ⓙ	HE 600 A	620	160	780	881				95,5	86,1	78,4	66,5	61,8	57,7	51,0	48,2	43,4	37,8	33,5	28,4	18,3	12,5
Ⓚ	HE 650 A	670	170	840	956					96,8	87,2	72,9	67,4	62,6	58,5	54,9	46,3	41,9	38,3	33,9	22,5	15,3
Ⓛ	HE 700 A	725	185	910	1032							92,6	77,4	71,5	66,5	62,1	54,8	49,1	44,5	39,0	27,6	18,8
Ⓜ	HE 800 A	830	210	1040	1183								91,0	82,9	76,1	70,3	61,0	53,9	50,9	45,8	38,3	26,2
Ⓝ	HE 900 A	935	235	1170	1334										93,4	85,1	72,2	67,0	58,8	52,3	44,9	35,9

Chart 3: Non-composite ACB® based on HEB, S355, e=1.25 a₀

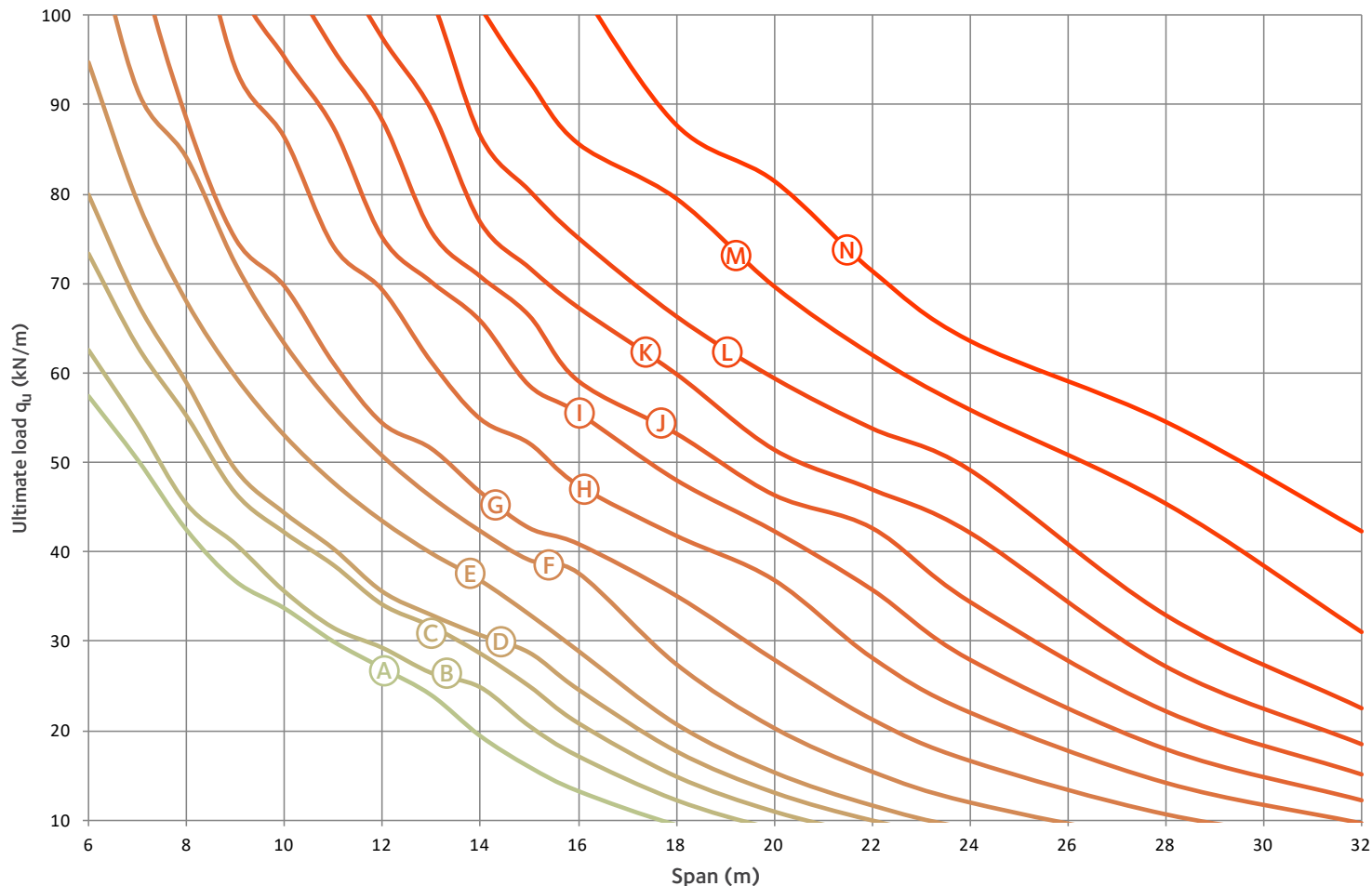

Sections	Dimensions (mm)				Ultimate load q _u (kN/m) according to the span (m)																	
	a ₀	w	e	H _t	6	7	8	9	10	11	12	13	14	15	16	18	20	22	24	28	32	
Ⓐ	HE 280 B	295	75	370	414	57,5	50,4	42,5	36,8	33,7	30,0	27,0	24,0	19,4	16,0	13,3						
Ⓑ	HE 300 B	315	75	390	445	62,6	54,4	45,4	40,9	35,6	31,6	29,3	26,5	24,9	20,6	17,2	12,3					
Ⓒ	HE 320 B	335	85	420	474	73,4	63,1	55,3	46,7	42,2	38,6	34,2	31,8	28,7	25,1	20,9	15,0	11,0				
Ⓓ	HE 340 B	355	85	440	504	80,0	67,9	58,9	49,2	44,3	40,4	35,6	32,9	30,7	28,7	24,6	17,7	13,1				
Ⓔ	HE 360 B	380	100	480	535	94,8	79,2	68,1	59,6	53,1	47,8	43,5	39,9	36,9	33,1	29,0	20,8	15,4	11,7			
Ⓕ	HE 400 B	420	110	530	594		91,8	84,2	72,3	63,4	56,4	50,8	46,3	42,4	39,2	37,7	27,5	20,4	15,5	12,1		
Ⓖ	HE 450 B	475	115	590	672			88,5	75,1	69,8	61,1	54,4	51,6	46,7	42,7	40,9	35,1	28,0	21,3	16,6	10,6	
Ⓗ	HE 500 B	525	135	660	745				94,1	86,4	74,2	69,3	61,2	54,9	52,1	47,4	41,8	36,8	28,1	22,0	14,1	
Ⓘ	HE 550 B	580	150	730	822					95,3	87,5	75,1	70,2	65,8	58,6	55,5	48,0	42,3	35,8	27,9	17,9	12,2
Ⓙ	HE 600 B	630	160	790	896						96,2	88,2	75,8	70,8	66,4	59,1	53,3	46,4	42,7	34,4	22,2	15,1
Ⓚ	HE 650 B	685	175	860	973							97,5	89,5	76,9	71,8	67,4	59,9	51,5	47,0	42,2	27,2	18,5
Ⓛ	HE 700 B	735	185	920	1047									86,5	80,4	75,1	66,3	59,4	53,8	49,1	32,9	22,5
Ⓜ	HE 800 B	840	210	1050	1198										92,7	85,7	79,5	69,7	62,0	55,9	45,4	31,0
Ⓝ	HE 900 B	945	235	1180	1349												87,8	81,5	71,5	63,6	54,6	42,3

Chart 4: Non-composite ACB[®] based on IPE, S355, e=1.5 a₀

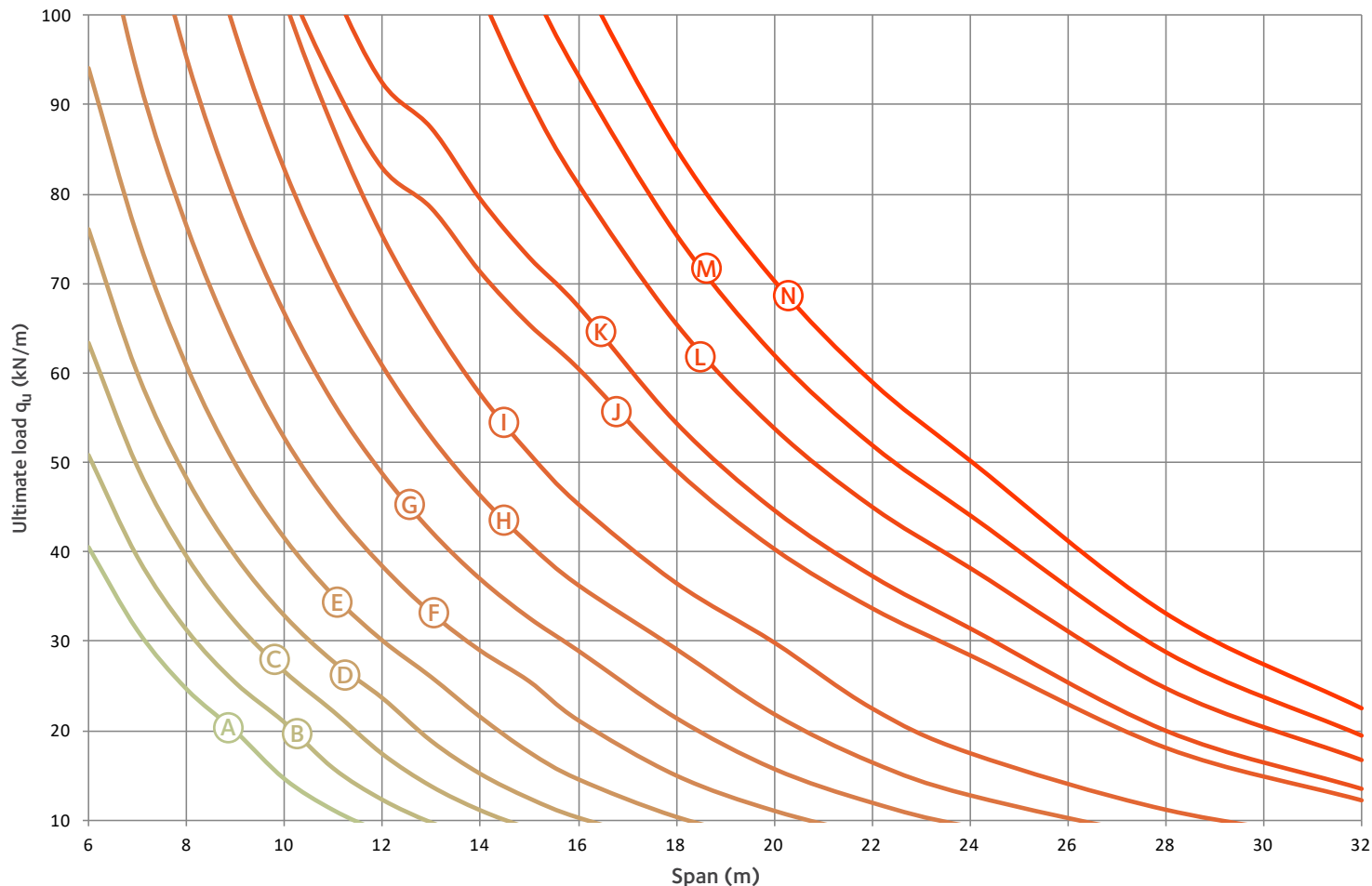

Sections	Dimensions (mm)				Ultimate load q _u (kN/m) according to the span (m)																	
	a ₀	w	e	H _t	6	7	8	9	10	11	12	13	14	15	16	18	20	22	24	28	32	
(A)	IPE 270	285	140	425	385	40,5	31,2	24,7	19,9	14,6	11,1											
(B)	IPE 300	315	155	470	428	50,9	39,5	31,4	25,4	21,0	15,9	12,3										
(C)	IPE 330	345	170	515	471	63,3	49,4	39,5	32,1	26,6	22,1	17,4	13,8	11,1								
(D)	IPE 360	380	190	570	515	76,1	60,0	48,3	39,5	32,9	27,8	23,7	18,9	15,2	12,5	10,3						
(E)	IPE 400	420	210	630	573	94,2	75,3	60,9	49,8	41,6	35,1	30,1	26,0	21,5	17,6	14,6	10,4					
(F)	IPE 450	475	235	710	647		93,5	76,5	63,2	52,8	44,7	38,4	33,2	29,0	25,6	21,2	15,0	11,1				
(G)	IPE 500	525	260	785	719			95,3	79,2	66,7	56,6	48,7	42,3	36,9	32,6	28,9	21,4	15,7	11,9			
(H)	IPE 550	580	285	865	793				98,1	82,9	70,6	60,9	52,9	46,4	40,9	36,4	29,2	21,9	16,5	12,8		
(I)	IPE 600	630	310	940	865						87,4	75,3	65,7	57,6	51,0	45,3	36,5	29,9	22,5	17,5	11,1	
(J)	IPE 750 x 134	755	392,5	1147,5	1081						92,5	83,0	78,5	71,3	65,5	60,6	49,2	40,4	33,8	28,5	18,1	12,3
(K)	IPE 750 x 147	755	395	1150	1086							92,5	87,5	79,5	73,0	67,5	54,5	44,7	37,4	31,5	20,1	13,6
(L)	IPE 750 x 173	765	397,5	1162,5	1097									90,7	81,1	65,5	53,9	45,1	38,2	24,8	16,7	
(M)	IPE 750 x 196	770	400	1170	1107										93,4	75,5	62,1	52,0	44,2	28,9	19,5	
(N)	IPE 750 x 220	780	402,5	1182,5	1118												85,2	70,4	59,1	50,3	33,2	22,6

Chart 5: Non-composite ACB[®] based on HEB, S355, e=1.5 a₀

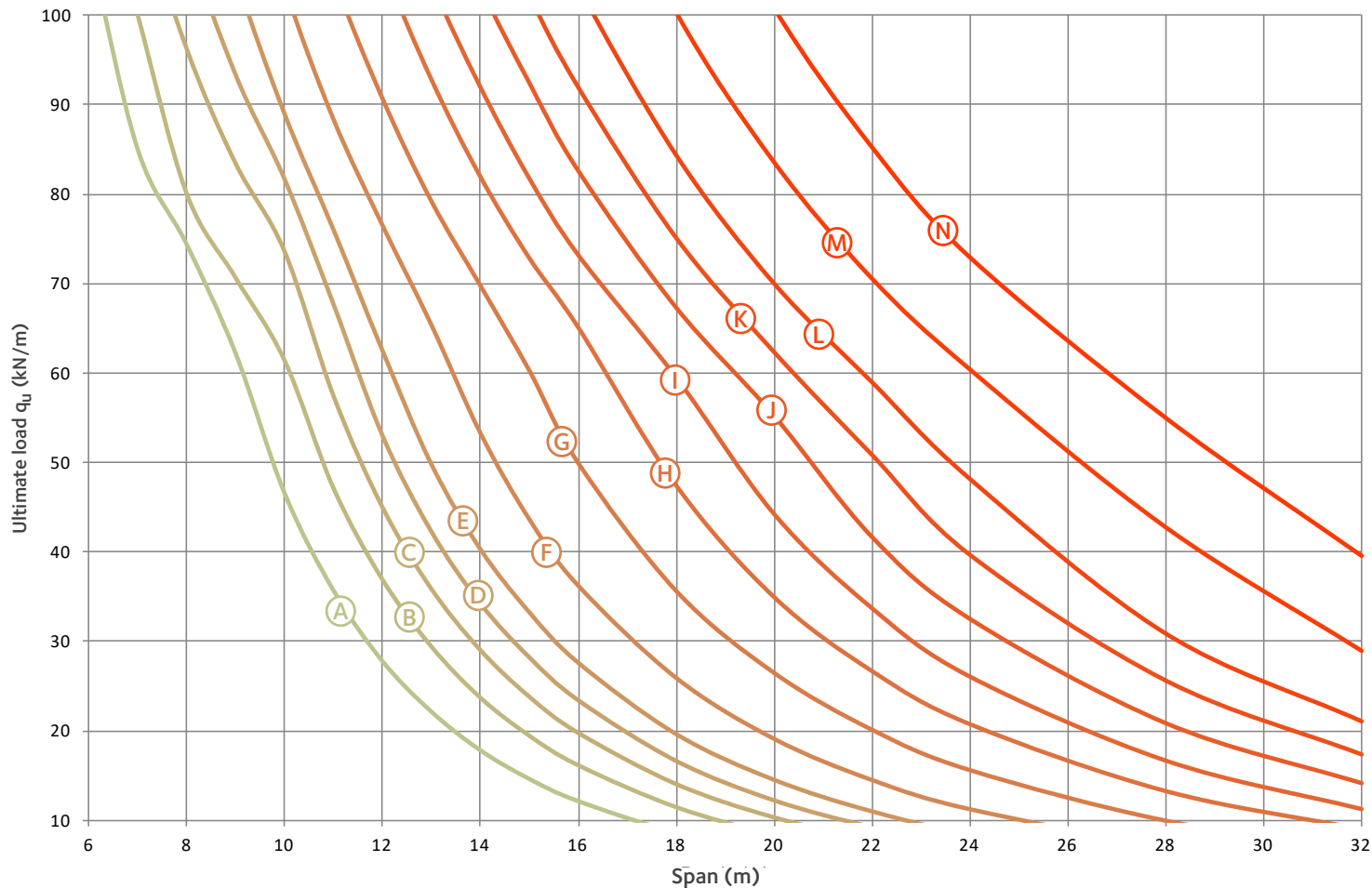

Sections	Dimensions (mm)				Ultimate load q _u (kN/m) according to the span (m)																		
	a ₀	w	e	H _t	6	7	8	9	10	11	12	13	14	15	16	18	20	22	24	28	32		
(A)	HE 280 B	280	140	420	392		85,2	74,5	62,3	46,7	35,8	27,8	22,2	17,8	14,6	12,1							
(B)	HE 300 B	310	150	460	426			80,2	70,7	61,5	47,2	37,0	29,5	23,8	19,5	16,2	11,5						
(C)	HE 320 B	335	165	500	457			96,4	83,6	73,7	57,6	45,1	35,9	29,1	23,9	19,8	14,1	10,4					
(D)	HE 340 B	355	175	530	485				93,5	81,8	67,8	53,1	42,3	34,3	28,3	23,5	16,7	12,3					
(E)	HE 360 B	380	190	570	515					89,0	76,1	62,6	49,8	40,3	33,2	27,6	19,6	14,5	10,9				
(F)	HE 400 B	420	210	630	573						88,5	76,6	65,5	53,4	43,7	36,3	25,9	19,1	14,5	11,2			
(G)	HE 450 B	475	235	710	647							90,7	79,2	69,8	60,3	49,9	35,6	26,4	20,1	15,6			
(H)	HE 500 B	525	260	785	719								92,8	82,0	72,8	65,1	47,4	34,9	26,6	20,7	13,2		
(I)	HE 550 B	580	290	870	792									92,1	81,8	73,3	59,6	44,3	33,8	26,1	16,7	11,3	
(J)	HE 600 B	630	310	940	865										92,5	82,6	67,3	55,2	41,7	32,5	20,8	14,1	
(K)	HE 650 B	685	340	1025	938											92,0	75,1	62,3	50,8	39,6	25,6	17,3	
(L)	HE 700 B	735	365	1100	1010												84,3	70,0	58,9	48,1	30,8	21,0	
(M)	HE 800 B	840	420	1260	1154													83,5	70,5	60,4	42,7	28,9	
(N)	HE 900 B	945	470	1415	1301															85,2	72,9	54,9	39,5

Chart 6: Non-composite ACB[®] based on HEM, S355, e=1.5 a₀

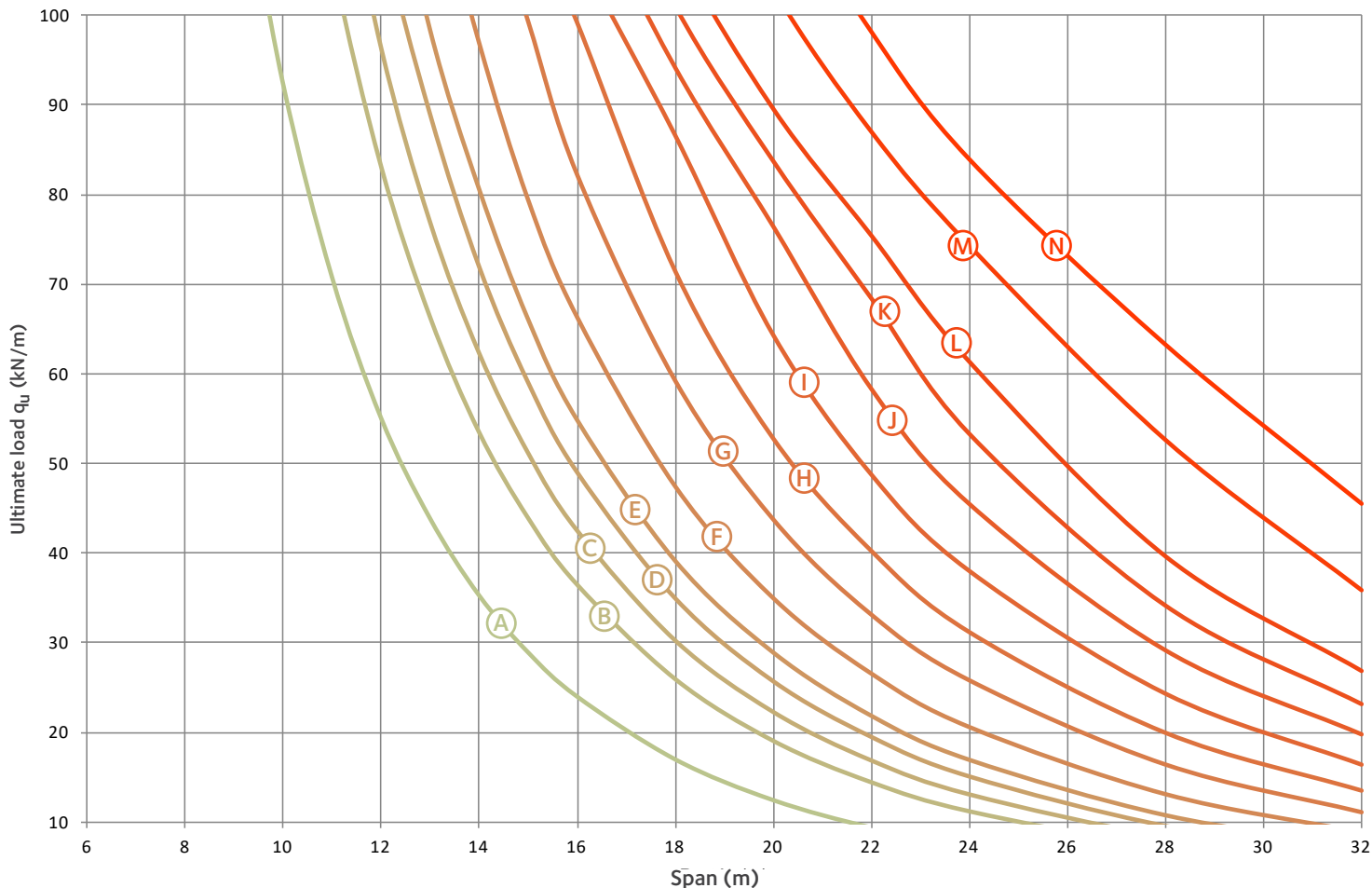

Sections	Dimensions (mm)				Ultimate load q _u (kN/m) according to the span (m)																	
	a ₀	w	e	H _t	6	7	8	9	10	11	12	13	14	15	16	18	20	22	24	28	32	
Ⓐ	HE 280 M	280	140	420	422					92,5	70,9	55,1	43,9	35,3	29,0	24,1	17,0	12,5				
Ⓑ	HE 300 M	310	150	460	466						83,2	66,3	53,4	43,9	36,4	25,9	19,0	14,4	11,1			
Ⓒ	HE 320 M	340	165	505	498						96,4	76,9	62,3	51,1	42,5	30,2	22,2	16,8	13,0			
Ⓓ	HE 340 M	380	180	560	535							89,1	72,1	59,1	49,1	35,0	25,8	19,6	15,1			
Ⓔ	HE 360 M	410	195	605	566							98,4	80,7	66,2	54,9	39,2	29,0	21,9	17,0	10,8		
Ⓕ	HE 400 M	450	220	670	619								97,0	79,5	66,4	47,5	35,0	26,6	20,6	13,1		
Ⓖ	HE 450 M	500	245	745	687									99,4	82,3	59,3	43,8	33,2	25,8	16,5	11,1	
Ⓗ	HE 500 M	540	270	810	749										99,1	71,4	52,7	40,2	31,1	19,9	13,4	
Ⓘ	HE 550 M	600	300	900	823											86,7	64,4	48,8	38,1	24,4	16,4	
Ⓙ	HE 600 M	650	320	970	894											94,1	76,4	58,3	45,4	29,1	19,7	
Ⓚ	HE 650 M	700	350	1050	962												83,7	68,4	53,3	34,1	23,1	
Ⓛ	HE 700 M	750	375	1125	1031												89,6	75,4	61,4	39,6	26,8	
Ⓜ	HE 800 M	855	425	1280	1176													87,1	74,3	52,7	35,9	
Ⓝ	HE 900 M	955	475	1430	1315													98,2	84,0	63,3	45,6	

Chart 7: Non-composite ACB[®] based on IPE, S460, e=1.5 a₀

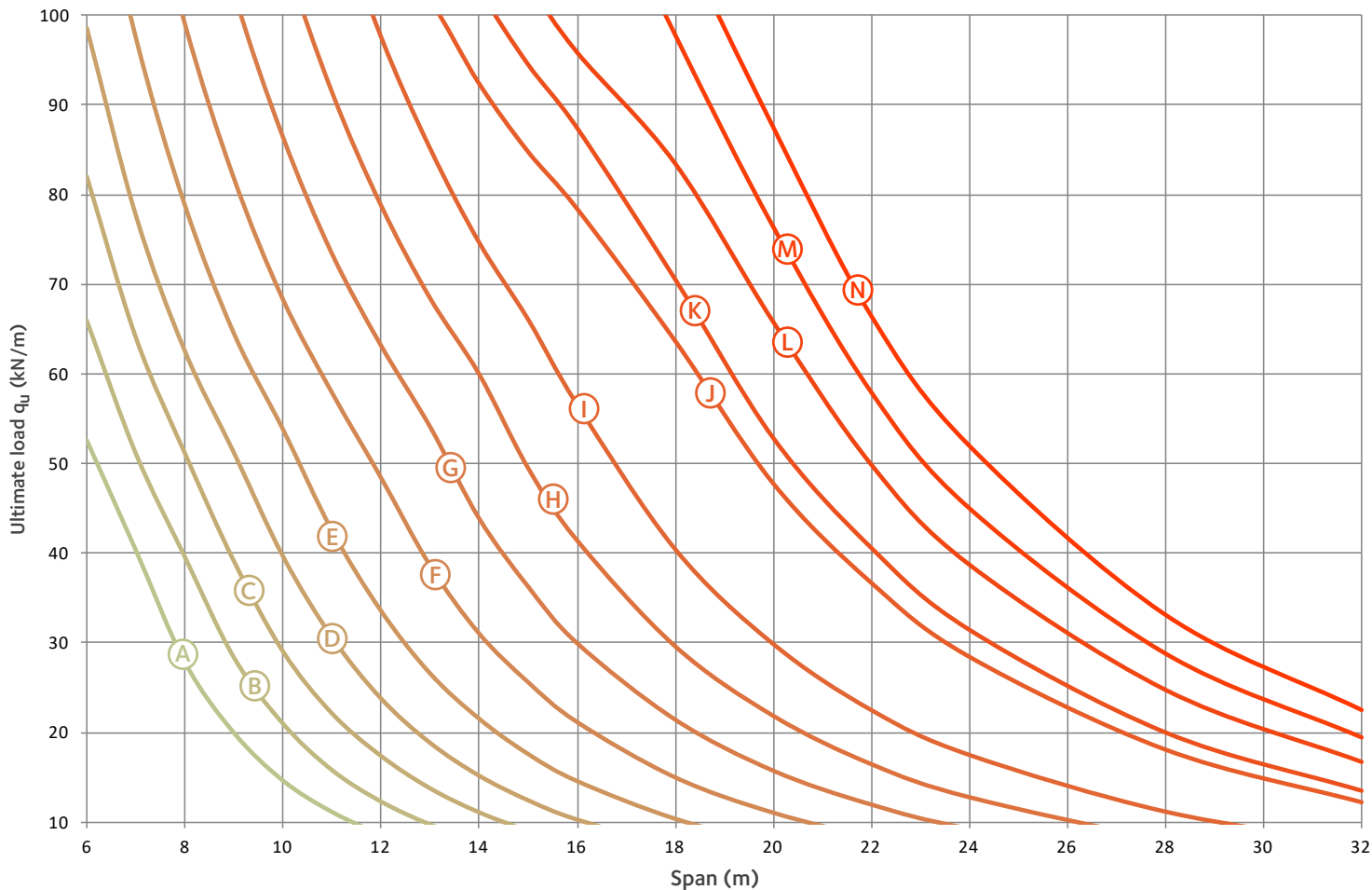

Sections	Dimensions (mm)				Ultimate load q _u (kN/m) according to the span (m)																	
	a ₀	w	e	H _t	6	7	8	9	10	11	12	13	14	15	16	18	20	22	24	28	32	
Ⓐ	IPE 270	285	140	425	385	52,5	40,3	27,8	19,9	14,6	11,1											
Ⓑ	IPE 300	315	155	470	428	66,0	51,1	39,6	28,4	21,0	15,9	12,3										
Ⓒ	IPE 330	345	170	515	471	82,0	64,1	51,2	39,1	29,1	22,1	17,4	13,8	11,1								
Ⓓ	IPE 360	380	190	570	515	98,6	77,7	62,6	51,2	39,7	30,7	23,8	18,9	15,2	12,5	10,3						
Ⓔ	IPE 400	420	210	630	573		97,6	78,9	64,6	53,9	42,5	33,6	26,6	21,5	17,6	14,6	10,4					
Ⓕ	IPE 450	475	235	710	647			99,1	81,9	68,4	58,0	48,5	38,7	31,1	25,7	21,2	15,0	11,1				
Ⓖ	IPE 500	525	260	785	719				102,6	86,4	73,4	63,1	54,1	43,9	36,2	29,9	21,4	15,7	11,9			
Ⓗ	IPE 550	580	285	865	793					107,4	91,5	78,9	68,5	60,1	49,6	41,5	29,7	21,9	16,5	12,8		
Ⓘ	IPE 600	630	310	940	865						113,2	97,6	85,2	74,7	66,1	56,6	40,4	29,9	22,5	17,5	11,1	
Ⓙ	IPE 750 x 134	755	392,5	1147,5	1081						119,9	107,5	101,7	92,5	84,8	78,5	63,7	47,8	36,7	28,5	18,1	12,3
Ⓚ	IPE 750 x 147	755	395	1150	1086							119,9	113,3	103,1	94,6	87,5	70,6	52,9	40,7	31,5	20,1	13,6
Ⓛ	IPE 750 x 173	765	397,5	1162,5	1097								113,2	103,8	95,9	83,5	65,8	49,9	38,7	24,8	16,7	
Ⓜ	IPE 750 x 196	770	400	1170	1107											97,9	76,5	58,0	45,1	28,9	19,5	
Ⓝ	IPE 750 x 220	780	402,5	1182,5	1118												110,4	87,6	66,5	52,1	33,2	22,6

Chart 8: Non-composite ACB[®] based on HEB, S460, e=1.5 a₀

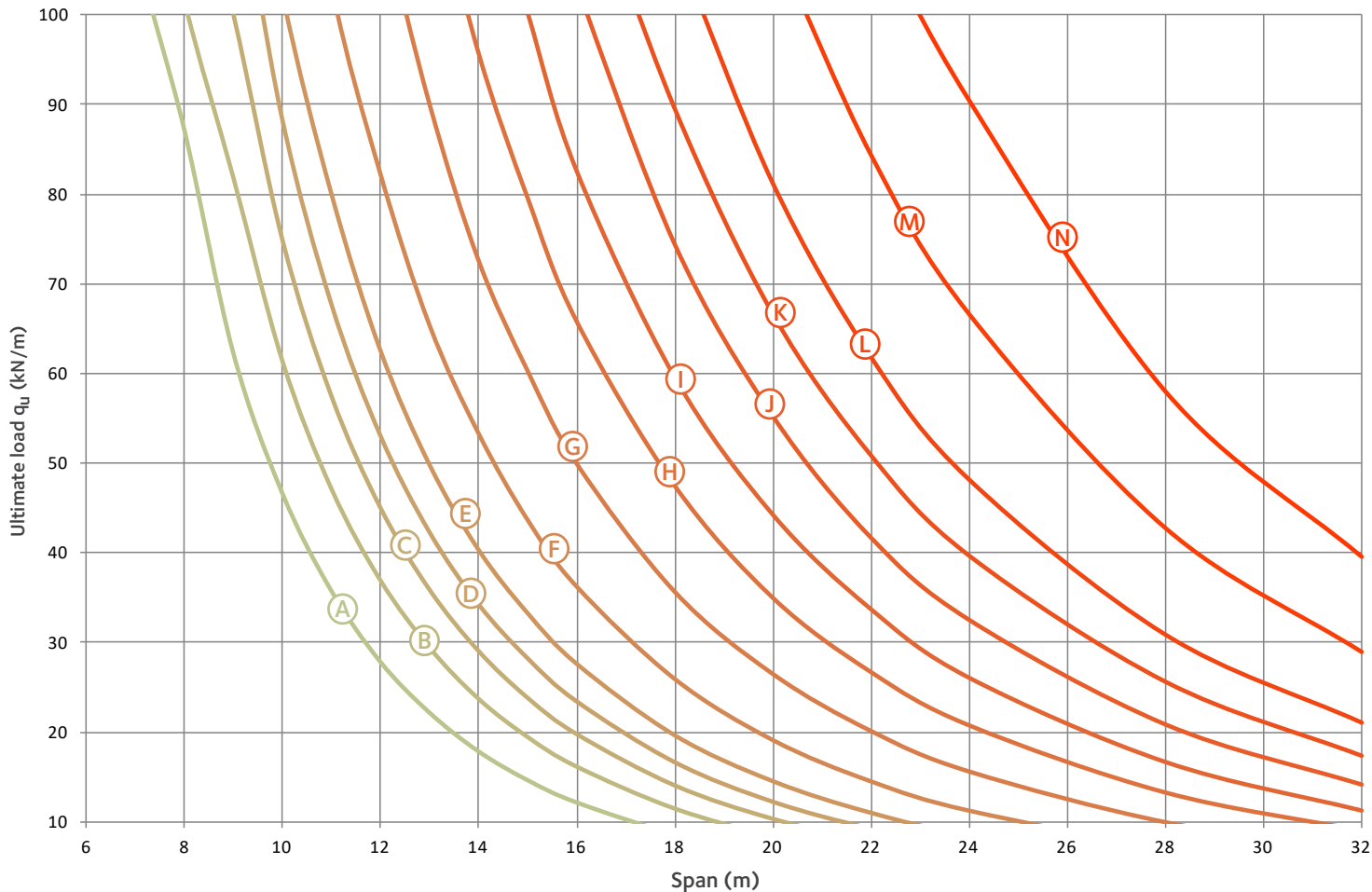

Sections	Dimensions (mm)				Ultimate load q _u (kN/m) according to the span (m)																	
	a ₀	w	e	H _t	6	7	8	9	10	11	12	13	14	15	16	18	20	22	24	28	32	
A	HE 280 B	280	140	420	392		108,3	87,3	62,3	46,7	35,8	27,8	22,2	17,8	14,6	12,1						
B	HE 300 B	310	150	460	426			101,8	82,0	61,5	47,2	37,0	29,5	23,8	19,5	16,2	11,5					
C	HE 320 B	335	165	500	457				100,2	75,1	57,6	45,1	35,9	29,1	23,9	19,8	14,1	10,4				
D	HE 340 B	355	175	530	485				118,2	88,4	67,8	53,1	42,3	34,3	28,3	23,5	16,7	12,3				
E	HE 360 B	380	190	570	515					102,4	80,1	62,6	49,8	40,3	33,2	27,6	19,6	14,5	10,9			
F	HE 400 B	420	210	630	573						103,3	82,3	65,5	53,4	43,7	36,3	25,9	19,1	14,5	11,2		
G	HE 450 B	475	235	710	647							111,9	90,1	72,6	60,3	49,9	35,6	26,4	20,1	15,6		
H	HE 500 B	525	260	785	719								117,1	95,7	79,5	65,8	47,4	34,9	26,6	20,7	13,2	
I	HE 550 B	580	290	870	792									119,3	100,3	82,7	59,6	44,3	33,8	26,1	16,7	11,3
J	HE 600 B	630	310	940	865										119,8	103,4	74,4	55,2	41,7	32,5	20,8	14,1
K	HE 650 B	685	340	1025	938											119,2	89,5	66,6	50,8	39,6	25,6	17,3
L	HE 700 B	735	365	1100	1010												108,0	81,1	61,8	48,1	30,8	21,0
M	HE 800 B	840	420	1260	1154													108,3	84,3	66,6	42,7	28,9
N	HE 900 B	945	470	1415	1301														110,4	90,4	57,9	39,5

Chart 9: Non-composite ACB® based on HEM, S460, e=1.5 a₀

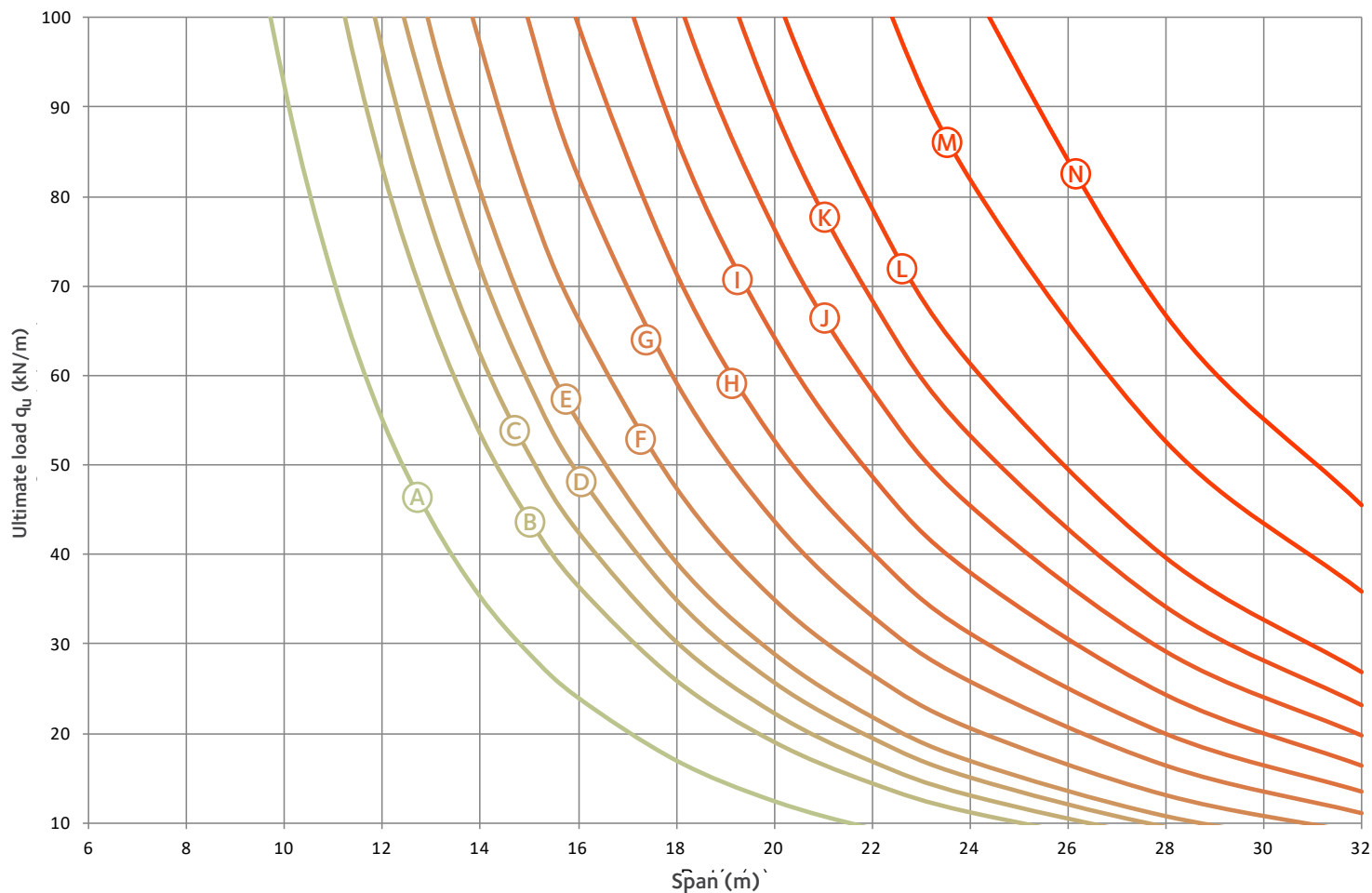

Sections	Dimensions (mm)				Ultimate load q _u (kN/m) according to the span (m)																	
	a ₀	w	e	H _t	6	7	8	9	10	11	12	13	14	15	16	18	20	22	24	28	32	
Ⓐ	HE 280 M	280	140	420	422					92,5	70,9	55,1	43,9	35,3	29,0	24,1	17,0	12,5				
Ⓑ	HE 300 M	310	150	460	466					106,1	83,2	66,3	53,4	43,9	36,4	25,9	19,0	14,4	11,1			
Ⓒ	HE 320 M	340	165	505	498						96,4	76,9	62,3	51,1	42,5	30,2	22,2	16,8	13,0			
Ⓓ	HE 340 M	380	180	560	535						110,2	89,1	72,1	59,1	49,1	35,0	25,8	19,6	15,1			
Ⓔ	HE 360 M	410	195	605	566							98,4	80,7	66,2	54,9	39,2	29,0	21,9	17,0	10,8		
Ⓕ	HE 400 M	450	220	670	619							118,1	97,0	79,5	66,4	47,5	35,0	26,6	20,6	13,1		
Ⓖ	HE 450 M	500	245	745	687									99,4	82,3	59,3	43,8	33,2	25,8	16,5	11,1	
Ⓗ	HE 500 M	540	270	810	749									118,7	99,1	71,4	52,7	40,2	31,1	19,9	13,4	
Ⓘ	HE 550 M	600	300	900	823											86,7	64,4	48,8	38,1	24,4	16,4	
Ⓙ	HE 600 M	650	320	970	894											102,7	76,4	58,3	45,4	29,1	19,7	
Ⓚ	HE 650 M	700	350	1050	962												89,8	68,4	53,3	34,1	23,1	
Ⓛ	HE 700 M	750	375	1125	1031												103,3	78,7	61,4	39,6	26,8	
Ⓜ	HE 800 M	855	425	1280	1176													105,6	82,0	52,7	35,9	
Ⓝ	HE 900 M	955	475	1430	1315														104,1	66,8	45,6	

Chart 10: Composite ACB® based on IPE, S355, e=1.5 a₀

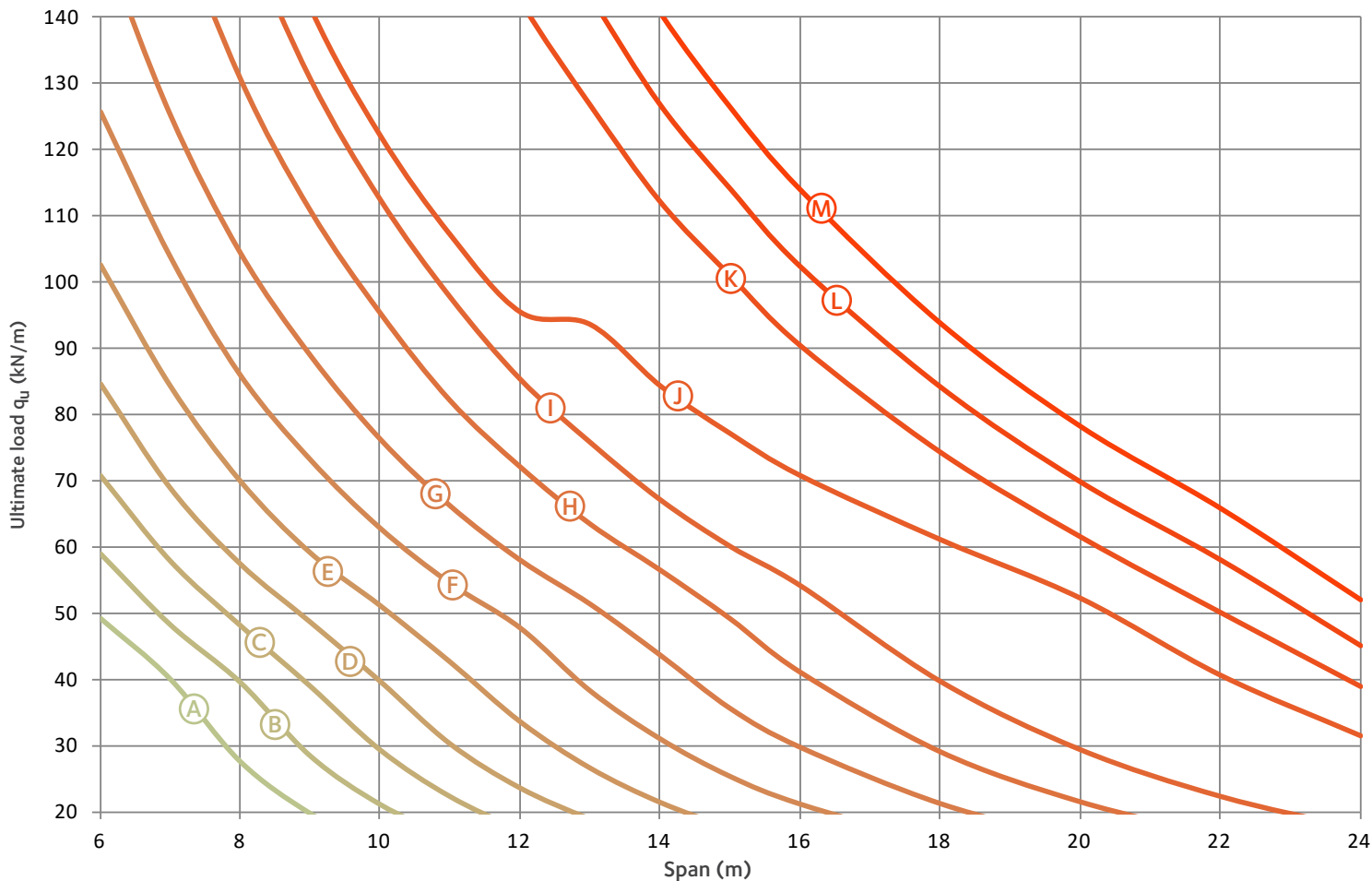

Sections	Dimensions (mm)				Ultimate load q _u (kN/m) according to the span (m)															
	a ₀	w	e	H _t	6	7	8	9	10	11	12	13	14	15	16	18	20	22	24	
(A) IPE 270	285	142,5	427,5	384	49,2	40,1	27,7													
(B) IPE 300	315	157,5	472,5	427	58,9	48,1	39,4	28,3	20,9											
(C) IPE 330	345	172,5	517,5	470	70,8	57,9	48,1	39,0	29,3	22,3										
(D) IPE 360	375	187,5	562,5	513	84,7	68,9	57,4	48,6	39,7	30,2	23,5									
(E) IPE 400	415	207,5	622,5	570	102,4	84,1	69,8	59,0	51,0	42,5	33,5	26,5	21,4							
(F) IPE 450	465	232,5	697,5	642	125,5	103,6	85,8	73,0	62,7	54,4	47,6	38,1	30,9	25,2	21,0					
(G) IPE 500	515	257,5	772,5	714		125,2	104,4	88,9	76,2	66,2	58,0	51,3	43,6	35,6	29,7	21,2				
(H) IPE 550	555	277,5	832,5	781			130,7	110,8	95,3	82,0	72,0	63,4	56,4	49,1	41,0	29,0	21,4			
(I) IPE 600	615	307,5	922,5	857				130,6	112,4	97,6	85,2	75,7	67,0	60,0	54,1	39,6	29,3	22,2		
(J) IPE 750 x 147	755	395	1150	1086					122,1	107,1	95,5	93,6	84,3	77,1	70,8	61,1	52,3	40,7	31,5	
(K) IPE 750 x 173	765	397,5	1162,5	1097								126,5	111,9	100,7	90,2	74,1	61,3	49,9	38,7	
(L) IPE 750 x 196	770	400	1170	1107									126,7	114,0	102,3	84,1	69,8	58,0	45,1	
(M) IPE 750 x 220	780	402,5	1182,5	1118										126,3	113,9	93,8	78,2	65,8	52,1	

Chart 11: Composite ACB® based on HEA, S355, $e=1.5 a_0$

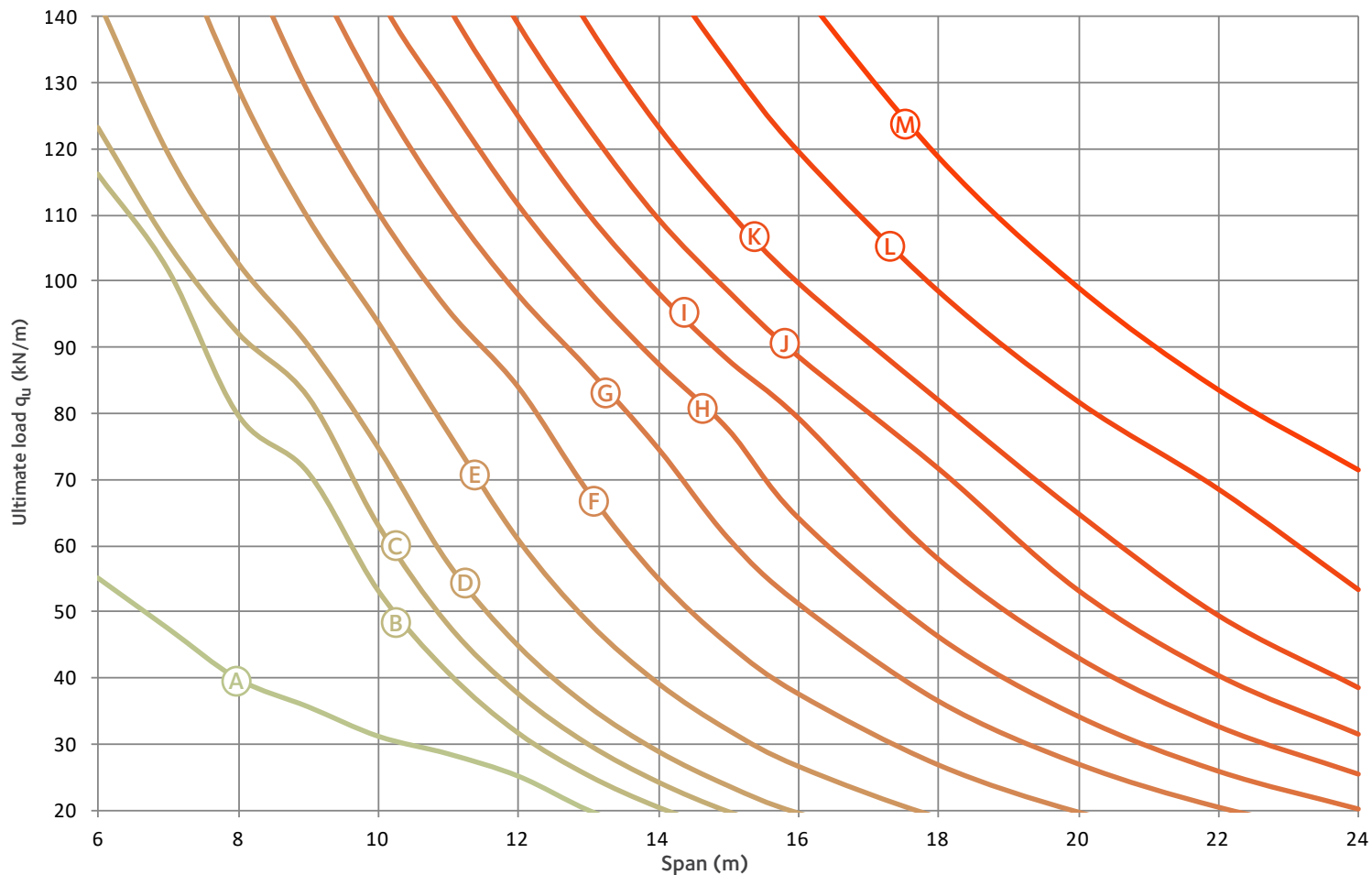

Sections	Dimensions (mm)				Ultimate load q_u (kN/m) according to the span (m)																
	a_0	w	e	H_t	6	7	8	9	10	11	12	13	14	15	16	18	20	22	24		
Ⓐ	HE 300 A	270	135	405	398	55,1	47,5	39,9	35,7	31,3	28,6	25,2	20,1								
Ⓑ	HE 320 A	290	145	435	426	116,2	101,7	79,7	71,0	53,1	40,7	31,6	25,2	20,4							
Ⓒ	HE 340 A	300	150	450	451	123,1	105,7	92,1	82,4	63,1	48,0	37,6	29,9	24,2							
Ⓓ	HE 360 A	320	160	480	479		119,3	102,8	90,4	74,9	57,4	44,9	35,8	28,9	23,7						
Ⓔ	HE 400 A	360	180	540	537			129,3	109,6	93,8	77,2	61,0	48,5	39,2	32,2	26,7					
Ⓕ	HE 450 A	410	205	615	608				128,7	110,5	95,7	84,0	68,2	55,1	45,1	37,6	26,9				
Ⓖ	HE 500 A	460	230	690	680					128,3	111,6	98,0	86,7	74,7	61,1	51,2	36,5	26,9	20,4		
Ⓗ	HE 550 A	500	250	750	747						127,0	111,6	98,7	87,6	77,6	64,2	46,3	34,2	25,9	20,1	
Ⓘ	HE 600 A	550	275	825	819							125,0	110,2	98,3	88,1	79,3	58,0	43,0	32,6	25,4	
Ⓙ	HE 650 A	600	300	900	891								138,9	123,1	109,4	98,4	88,6	71,6	53,2	40,3	31,4
Ⓚ	HE 700 A	650	325	975	962									138,8	123,4	110,7	99,7	82,0	64,8	49,4	38,5
Ⓛ	HE 800 A	740	370	1110	1101											133,1	119,8	98,6	81,9	68,7	53,4
Ⓜ	HE 900 A	840	420	1260	1244													118,7	98,9	83,5	71,3

Chart 12: Composite ACB® based on HEB, S355, e=1.5 a₀

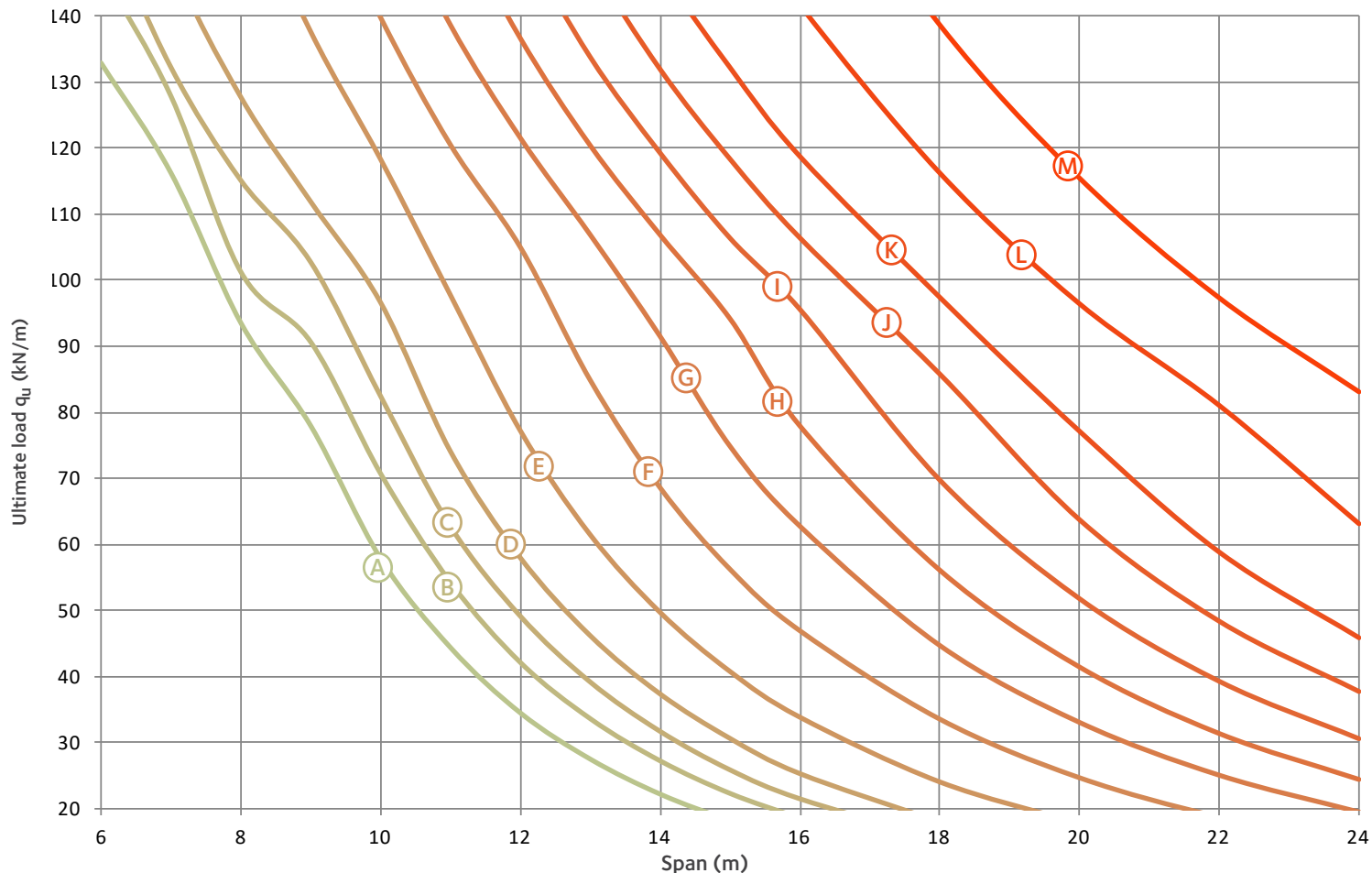

Sections	Dimensions (mm)				Ultimate load q _u (kN/m) according to the span (m)																
	a ₀	w	e	H _t	6	7	8	9	10	11	12	13	14	15	16	18	20	22	24		
Ⓐ	HE 300 B	270	135	405	408	132,8	116,1	93,4	77,8	57,7	44,2	34,3	27,3	22,1							
Ⓑ	HE 320 B	290	145	435	436		127,9	101,3	90,6	70,6	54,1	42,0	33,5	27,1	22,1						
Ⓒ	HE 340 B	300	150	450	461		132,3	115,2	102,8	82,6	62,8	49,2	39,2	31,7	25,9	21,5					
Ⓓ	HE 360 B	320	160	480	489			127,8	112,0	96,7	74,2	58,1	46,2	37,4	30,7	25,3					
Ⓔ	HE 400 B	360	180	540	547				137,8	118,4	97,9	77,3	61,5	49,8	40,8	33,9	24,1				
Ⓕ	HE 450 B	410	205	615	618					139,8	120,5	105,0	84,8	68,5	56,2	46,9	33,5	24,6			
Ⓖ	HE 500 B	460	230	690	690						138,7	121,6	106,9	91,5	74,8	62,7	44,7	33,0	25,0		
Ⓗ	HE 550 B	500	250	750	757							136,7	120,5	106,9	94,2	78,0	56,2	41,5	31,4	24,5	
Ⓘ	HE 600 B	550	275	825	829								133,9	119,4	106,5	95,7	69,9	51,9	39,3	30,6	
Ⓙ	HE 650 B	600	300	900	901									131,9	118,3	106,3	85,7	63,6	48,2	37,6	
Ⓚ	HE 700 B	650	325	975	972										132,1	118,7	97,3	77,0	58,7	45,7	
Ⓛ	HE 800 B	740	370	1110	1111												116,2	96,4	80,9	63,0	
Ⓜ	HE 900 B	840	420	1260	1254													138,6	115,4	97,3	83,0

Chart 13: Composite ACB® based on IPE, S460, $e=1.5 a_0$

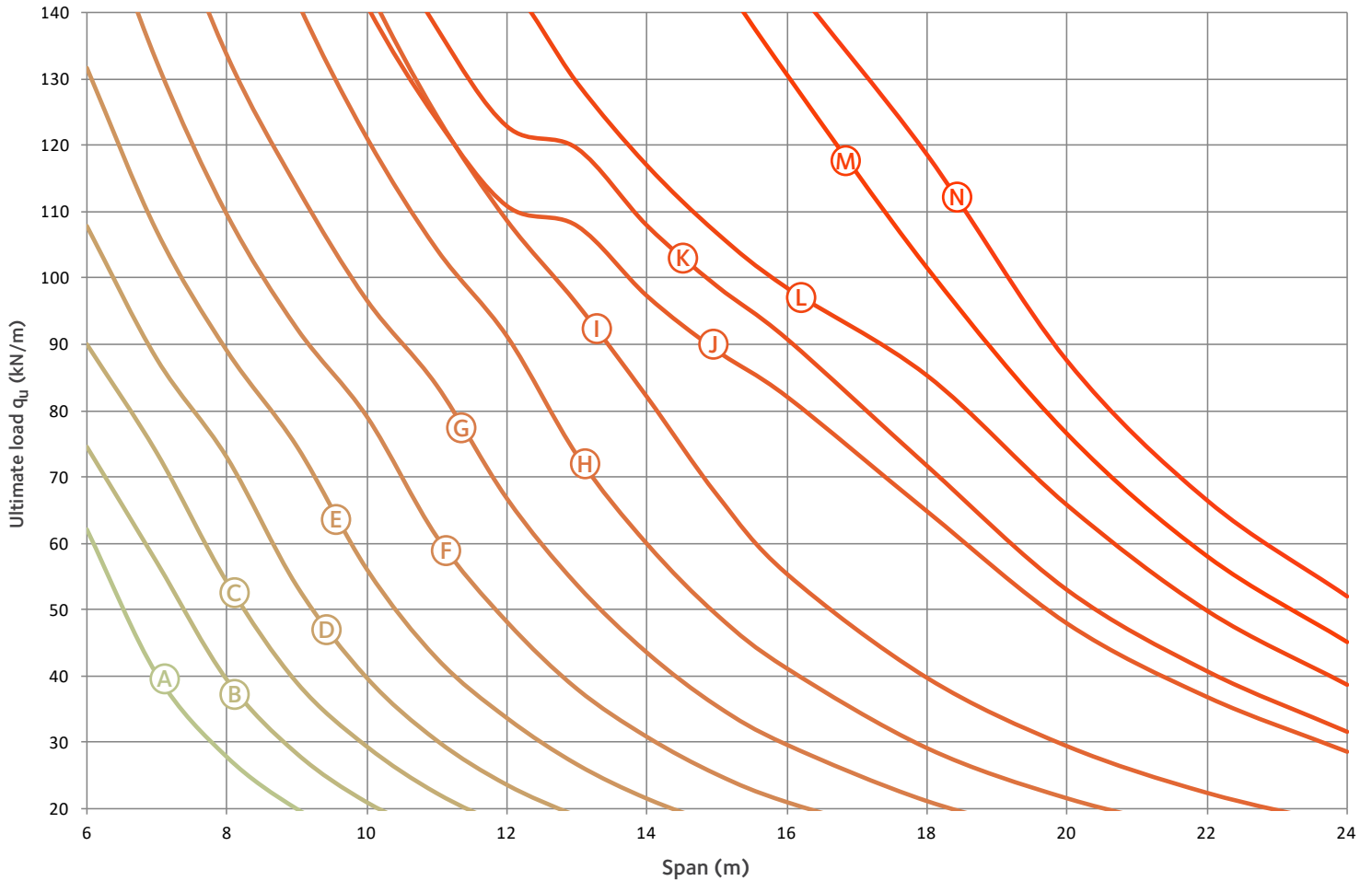

Sections		Dimensions (mm)				Ultimate load q_u (kN/m) according to the span (m)															
		a_0	w	e	H_t	6	7	8	9	10	11	12	13	14	15	16	18	20	22	24	
(A)	IPE 270	285	142,5	427,5	384	62,0	40,1	27,7													
(B)	IPE 300	315	157,5	472,5	427	74,6	57,1	39,4	28,3	20,9											
(C)	IPE 330	345	172,5	517,5	470	90,0	73,6	54,1	39,0	29,3	22,3										
(D)	IPE 360	375	187,5	562,5	513	107,8	87,7	72,9	53,5	39,7	30,2	23,5									
(E)	IPE 400	415	207,5	622,5	570	131,7	107,0	89,0	74,5	56,0	42,5	33,5	26,5	21,4							
(F)	IPE 450	465	232,5	697,5	642		132,7	109,7	92,5	79,2	61,1	48,3	38,1	30,9	25,2	21,0					
(G)	IPE 500	515	257,5	772,5	714			133,8	113,8	96,8	83,9	66,9	53,9	43,6	35,6	29,7	21,2				
(H)	IPE 550	555	277,5	832,5	781					121,1	104,3	91,2	73,2	59,8	49,1	41,0	29,0	21,4			
(I)	IPE 600	615	307,5	922,5	857						124,4	108,6	96,0	82,0	67,2	55,3	39,6	29,3	22,2		
(J)	IPE 750 x 134	755	392,5	1147,5	1081						123,9	110,8	107,8	97,2	89,0	82,0	64,8	47,8	36,7	28,5	
(K)	IPE 750 x 147	755	395	1150	1086						137,7	122,9	119,6	107,9	98,8	90,8	71,6	52,9	40,7	31,5	
(L)	IPE 750 x 173	765	397,5	1162,5	1097							129,6	117,1	106,9	98,6	85,4	65,8	49,9	38,7		
(M)	IPE 750 x 196	770	400	1170	1107										130,6	101,5	76,5	58,0	45,1		
(N)	IPE 750 x 220	780	402,5	1182,5	1118											118,7	87,6	66,5	52,1		

Chart 14: Composite ACB® based on HEA, S460, e=1.5 a₀

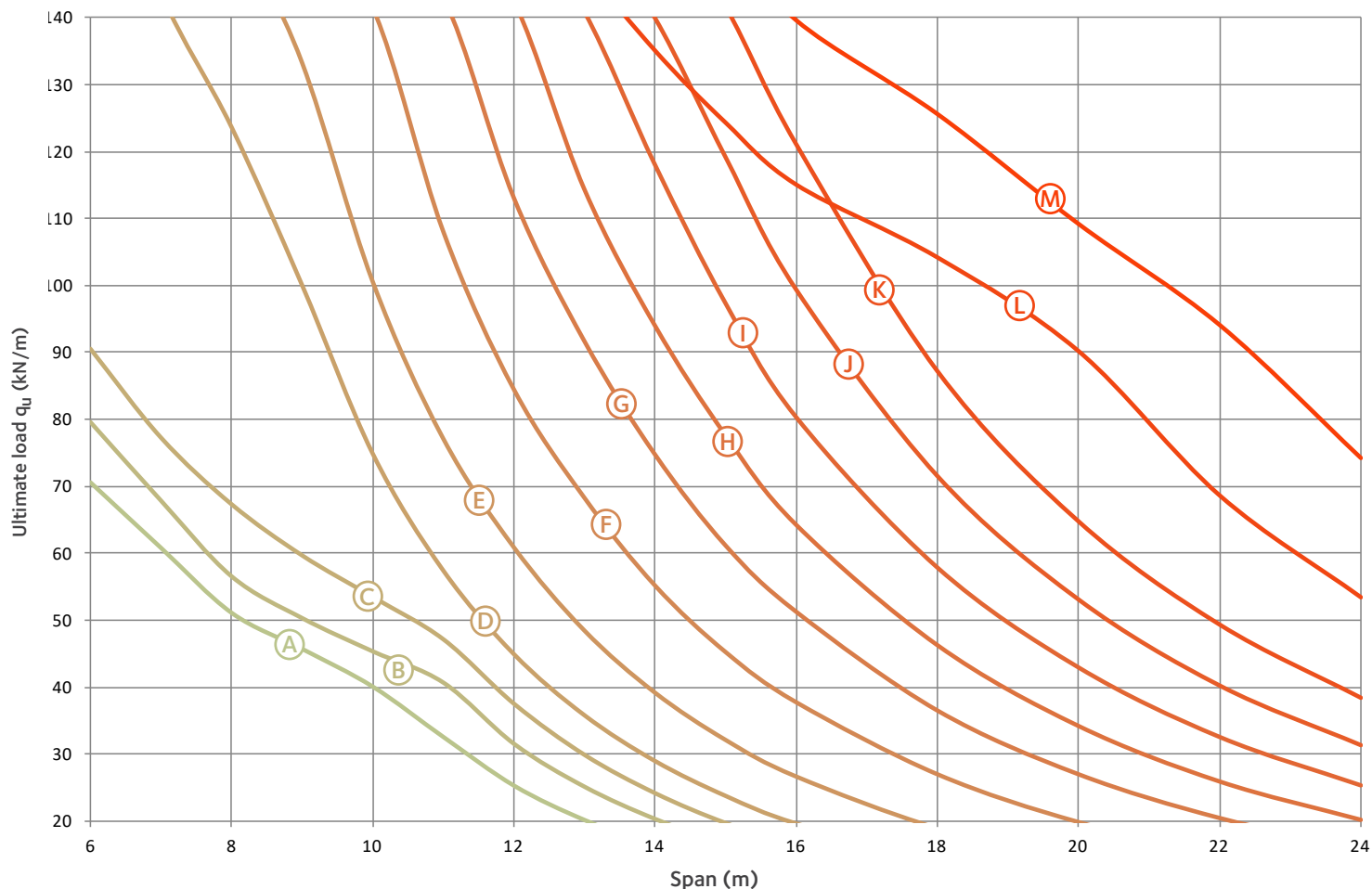

Sections	Dimensions (mm)				Ultimate load q _u (kN/m) according to the span (m)																	
	a ₀	w	e	H _t	6	7	8	9	10	11	12	13	14	15	16	18	20	22	24			
Ⓐ	HE 300 A	270	135	405	398	70,6	60,8	51,1	45,7	40,0	32,5	25,2	20,1									
Ⓑ	HE 320 A	290	145	435	426	79,6	67,9	56,6	50,4	45,4	40,7	31,6	25,2	20,4								
Ⓒ	HE 340 A	300	150	450	451	90,6	77,3	67,3	59,7	53,5	47,2	37,6	29,9	24,2								
Ⓓ	HE 360 A	320	160	480	479			123,7	100,0	74,9	57,4	44,9	35,8	28,9	23,7							
Ⓔ	HE 400 A	360	180	540	537				133,3	100,6	77,2	61,0	48,5	39,2	32,2	26,7						
Ⓕ	HE 450 A	410	205	615	608						107,9	84,4	68,2	55,1	45,1	37,6	26,9					
Ⓖ	HE 500 A	460	230	690	680							113,0	91,6	74,7	61,1	51,2	36,5	26,9	20,4			
Ⓗ	HE 550 A	500	250	750	747								114,3	94,0	77,6	64,2	46,3	34,2	25,9	20,1		
Ⓘ	HE 600 A	550	275	825	819									118,1	97,4	80,4	58,0	43,0	32,6	25,4		
Ⓙ	HE 650 A	600	300	900	891										119,2	99,4	71,6	53,2	40,3	31,4		
Ⓚ	HE 700 A	650	325	975	962											121,2	87,3	64,8	49,4	38,5		
Ⓛ	HE 800 A	740	370	1110	1101											135,1	124,4	115,1	104,2	90,2	68,7	53,4
Ⓜ	HE 900 A	840	420	1260	1244													139,7	125,7	109,2	94,1	74,3

Chart 15: Composite ACB® based on HEB, S460, e=1.5 a₀

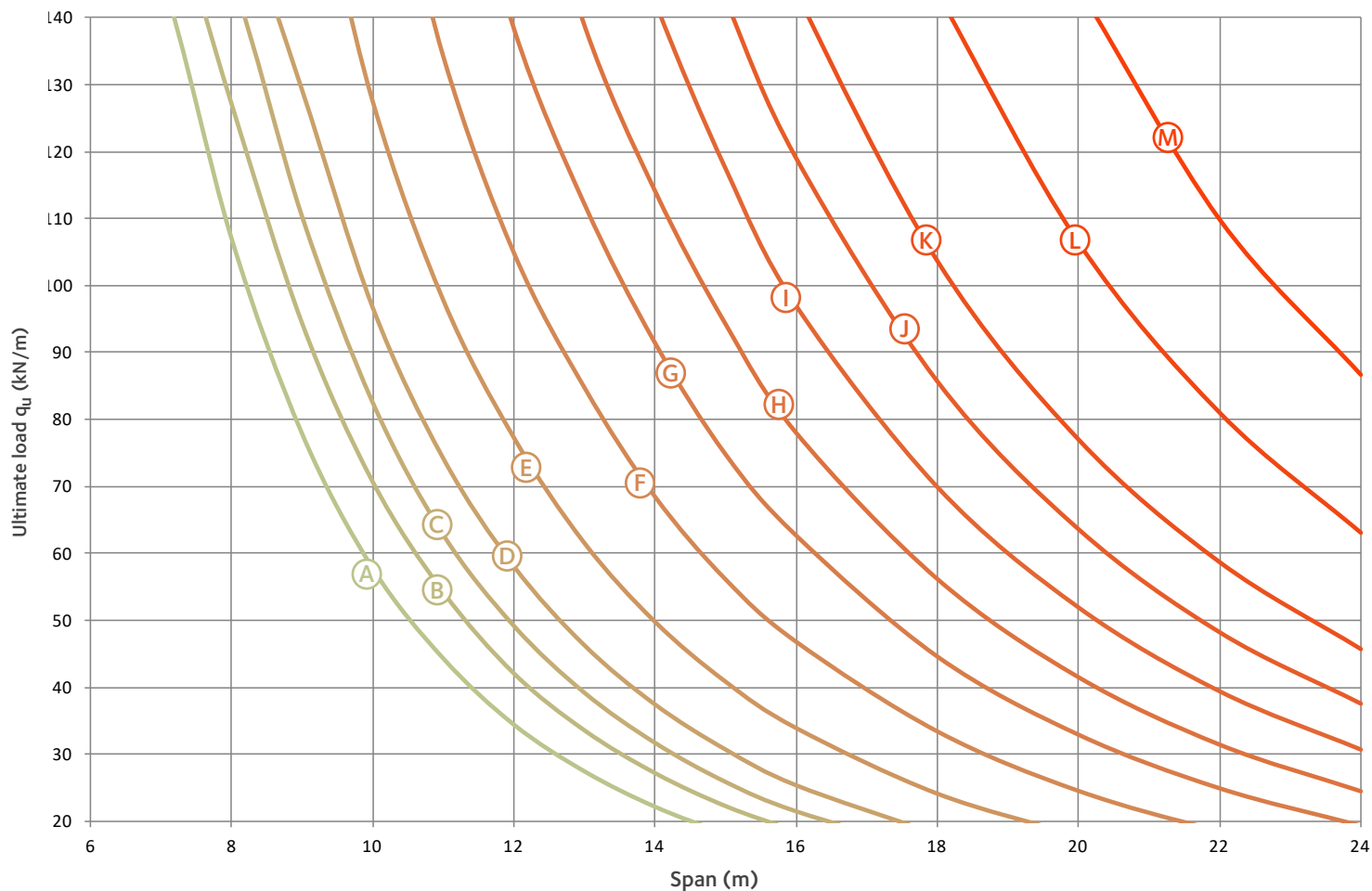

Sections	Dimensions (mm)				Ultimate load q _u (kN/m) according to the span (m)																
	a ₀	w	e	H _t	6	7	8	9	10	11	12	13	14	15	16	18	20	22	24		
Ⓐ	HE 300 B	270	135	405	408			107,0	77,8	57,7	44,2	34,3	27,3	22,1							
Ⓑ	HE 320 B	290	145	435	436			127,1	94,3	70,6	54,1	42,0	33,5	27,1	22,1						
Ⓒ	HE 340 B	300	150	450	461				110,3	82,6	62,8	49,2	39,2	31,7	25,9	21,5					
Ⓓ	HE 360 B	320	160	480	489				129,2	96,7	74,2	58,1	46,2	37,4	30,7	25,3					
Ⓔ	HE 400 B	360	180	540	547					127,6	97,9	77,3	61,5	49,8	40,8	33,9	24,1				
Ⓕ	HE 450 B	410	205	615	618						134,3	105,0	84,8	68,5	56,2	46,9	33,5	24,6			
Ⓖ	HE 500 B	460	230	690	690							138,4	112,2	91,5	74,8	62,7	44,7	33,0	25,0		
Ⓗ	HE 550 B	500	250	750	757								138,9	114,1	94,2	78,0	56,2	41,5	31,4	24,5	
Ⓘ	HE 600 B	550	275	825	829										117,4	96,9	69,9	51,9	39,3	30,6	
Ⓙ	HE 650 B	600	300	900	901											119,0	85,7	63,6	48,2	37,6	
Ⓚ	HE 700 B	650	325	975	972												103,7	77,0	58,7	45,7	
Ⓛ	HE 800 B	740	370	1110	1111													106,4	80,9	63,0	
Ⓜ	HE 900 B	840	420	1260	1254															109,8	86,7

12. Predesign charts for Angelina®

Chart 16: Non-composite Angelina® based on IPE, S355

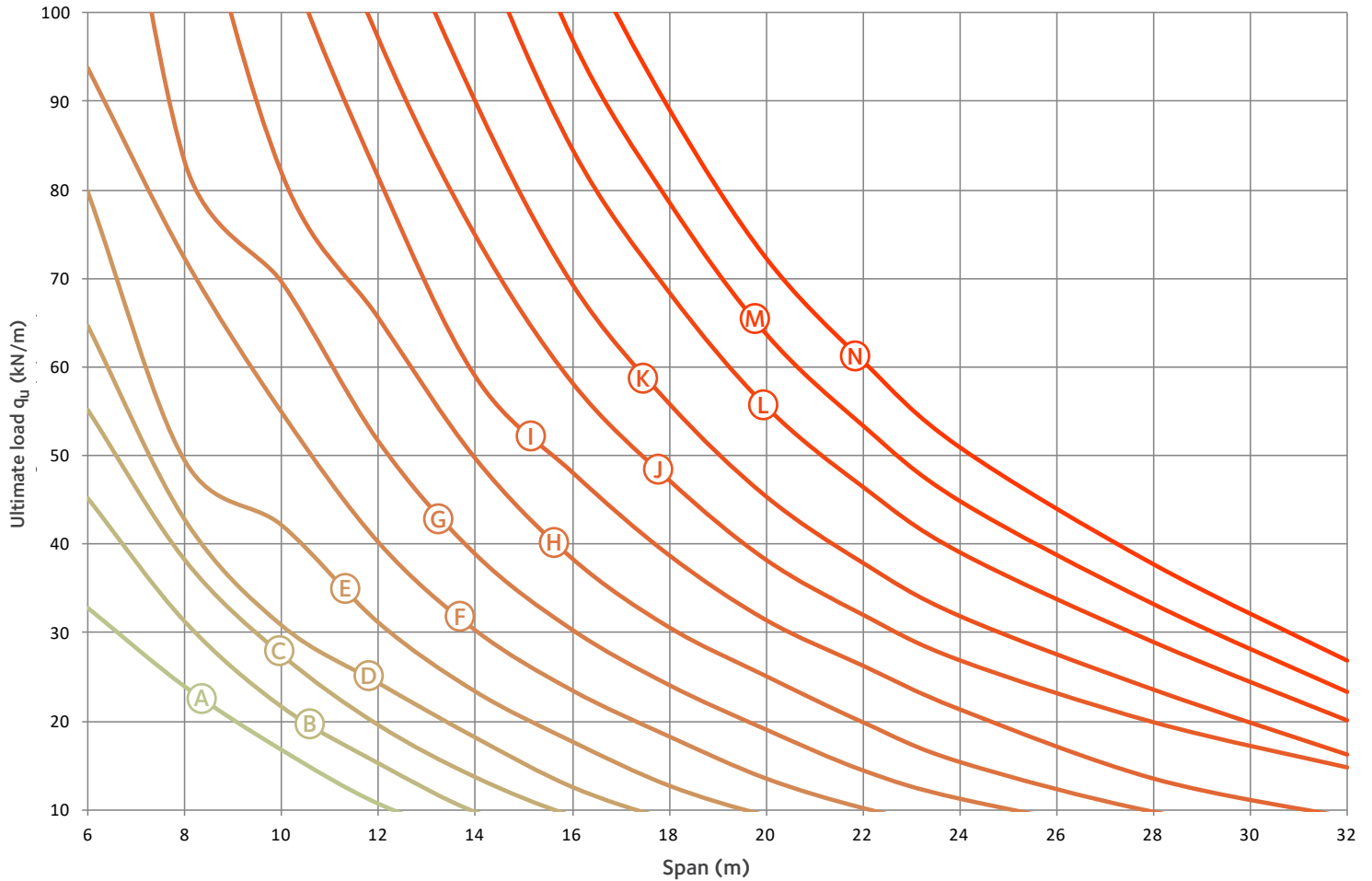

Sections	Dimensions (mm)					Ultimate load q_u (kN/m) according to the span (m)												
	a_0	w	s	e	H_t	6	8	10	12	14	16	18	20	22	24	28	32	
(A) IPE 270	285	200	285	970	412,5	32,7	23,9	16,7	10,6									
(B) IPE 300	315	200	315	1030	457,5	45,1	31,2	21,6	15,3									
(C) IPE 330	345	200	345	1090	502,5	55,2	38,3	27,5	19,5	13,6								
(D) IPE 360	375	250	375	1250	547,5	64,7	42,8	30,9	24,3	18,2	12,6							
(E) IPE 400	415	250	415	1330	607,5	79,8	49,4	42,1	31,1	23,3	17,7	12,7						
(F) IPE 450	465	250	465	1430	682,5	93,7	72,2	54,9	40,2	30,3	23,5	18,3	13,6	10,2				
(G) IPE 500	515	250	515	1530	757,5		83,2	69,6	51,6	38,9	30,3	24,1	19,1	14,5	11,3			
(H) IPE 550	555	250	555	1610	827,5			82,0	65,6	49,7	38,4	30,7	25,1	19,9	15,4			
(I) IPE 600	615	250	615	1730	907,5				81,4	58,9	48,1	38,7	31,4	26,3	21,3	13,5		
(J) IPE 750 x 134	755	250	755	2010	1130,5				97,1	74,9	58,3	47,3	38,3	32,1	26,9	19,9	14,8	
(K) IPE 750 x 147	755	250	755	2010	1130,5					90,0	69,4	55,9	45,4	37,9	31,9	23,6	16,2	
(L) IPE 750 x 173	765	250	765	2030	1144,5						84,6	68,4	55,5	46,4	39,0	28,9	20,0	
(M) IPE 750 x 196	770	250	770	2040	1155							97,0	78,6	63,7	53,4	44,8	33,2	23,3
(N) IPE 750 x 220	780	250	780	2060	1169								89,2	72,4	60,7	51,0	37,8	26,9

Chart 17: Non-composite Angelina® based on HEA, S355

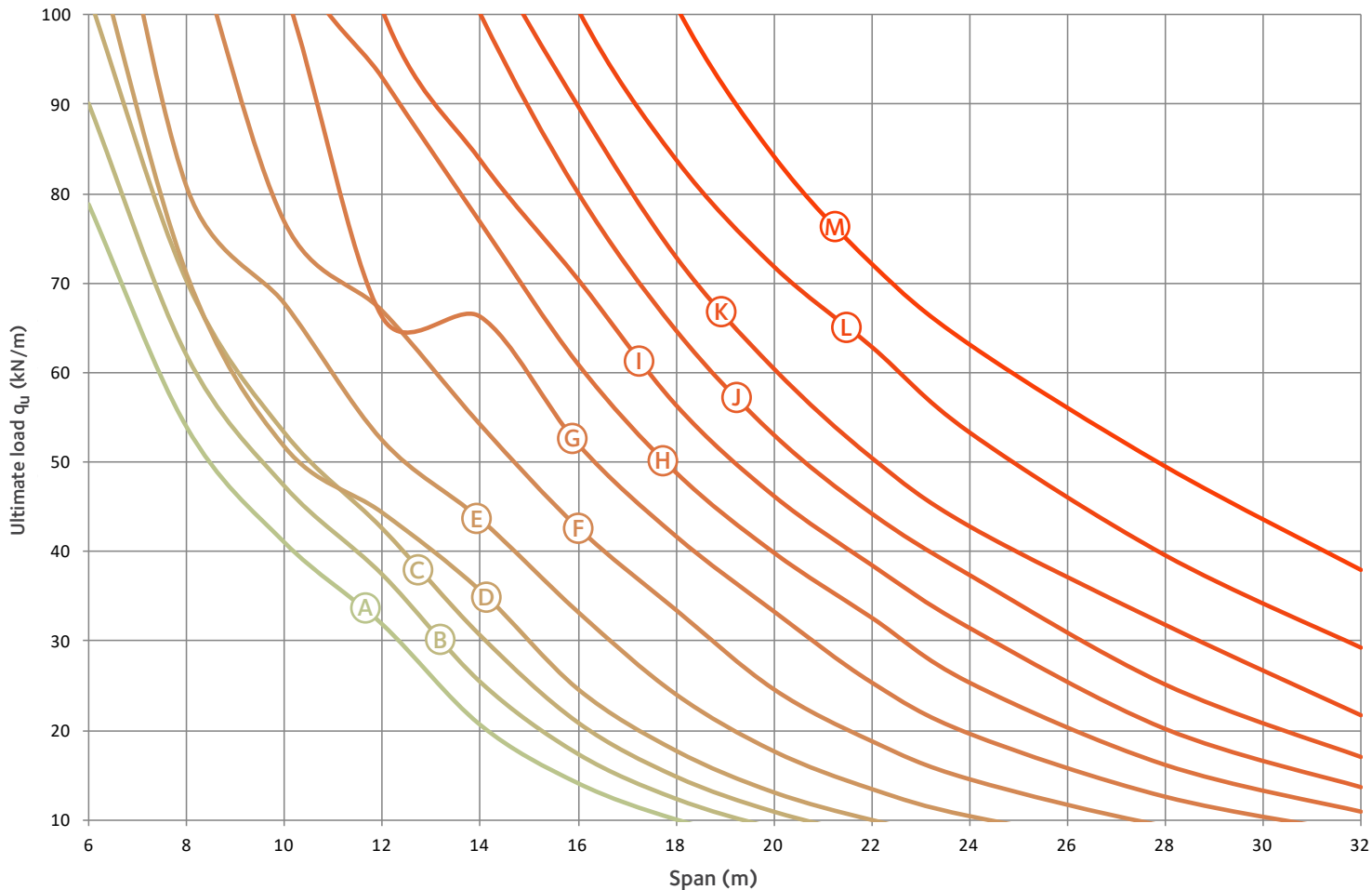

Sections	Dimensions (mm)					Ultimate load q_u (kN/m) according to the span (m)													
	a_0	w	s	e	H_t	6	8	10	12	14	16	18	20	22	24	28	32		
(A)	HE 300 A	305	200	305	1010	442,5	78,9	53,9	41,0	31,8	20,6	14,1	10,0						
(B)	HE 320 A	325	200	325	1050	472,5	90,1	62,0	47,4	37,5	25,5	17,4	12,4						
(C)	HE 340 A	340	200	340	1080	500		70,2	53,3	42,6	30,7	20,9	14,9	11,0					
(D)	HE 360 A	365	250	365	1230	532,5		71,0	51,7	44,3	35,6	24,6	17,7	13,0	10,0				
(E)	HE 400 A	405	250	405	1310	592,5		80,8	67,8	52,5	43,7	33,3	24,1	17,7	13,5	10,4			
(F)	HE 450 A	455	250	455	1410	667,5			77,0	67,0	54,3	42,7	33,6	24,7	18,9	14,6			
(G)	HE 500 A	500	250	500	1500	740				66,2	66,3	52,0	41,7	33,3	25,4	19,6	12,6		
(H)	HE 550 A	555	250	555	1610	817,5				93,1	76,9	61,0	48,9	40,0	32,7	25,4	16,2	11,0	
(I)	HE 600 A	600	250	600	1700	890					83,9	70,5	56,5	46,3	38,6	31,5	20,2	13,7	
(J)	HE 650 A	655	250	655	1810	967,5						80,2	64,8	53,1	44,3	37,4	25,2	17,1	
(K)	HE 700 A	755	250	755	2010	1067,5							89,9	73,0	60,5	50,6	42,9	31,9	21,8
(L)	HE 800 A	805	250	805	2110	1192,5								83,8	71,8	62,9	53,3	39,5	29,2
(M)	HE 900 A	900	250	900	2300	1340									84,3	72,2	63,2	49,6	38,0

Chart 18: Non-composite Angelina® based on HEA, S460

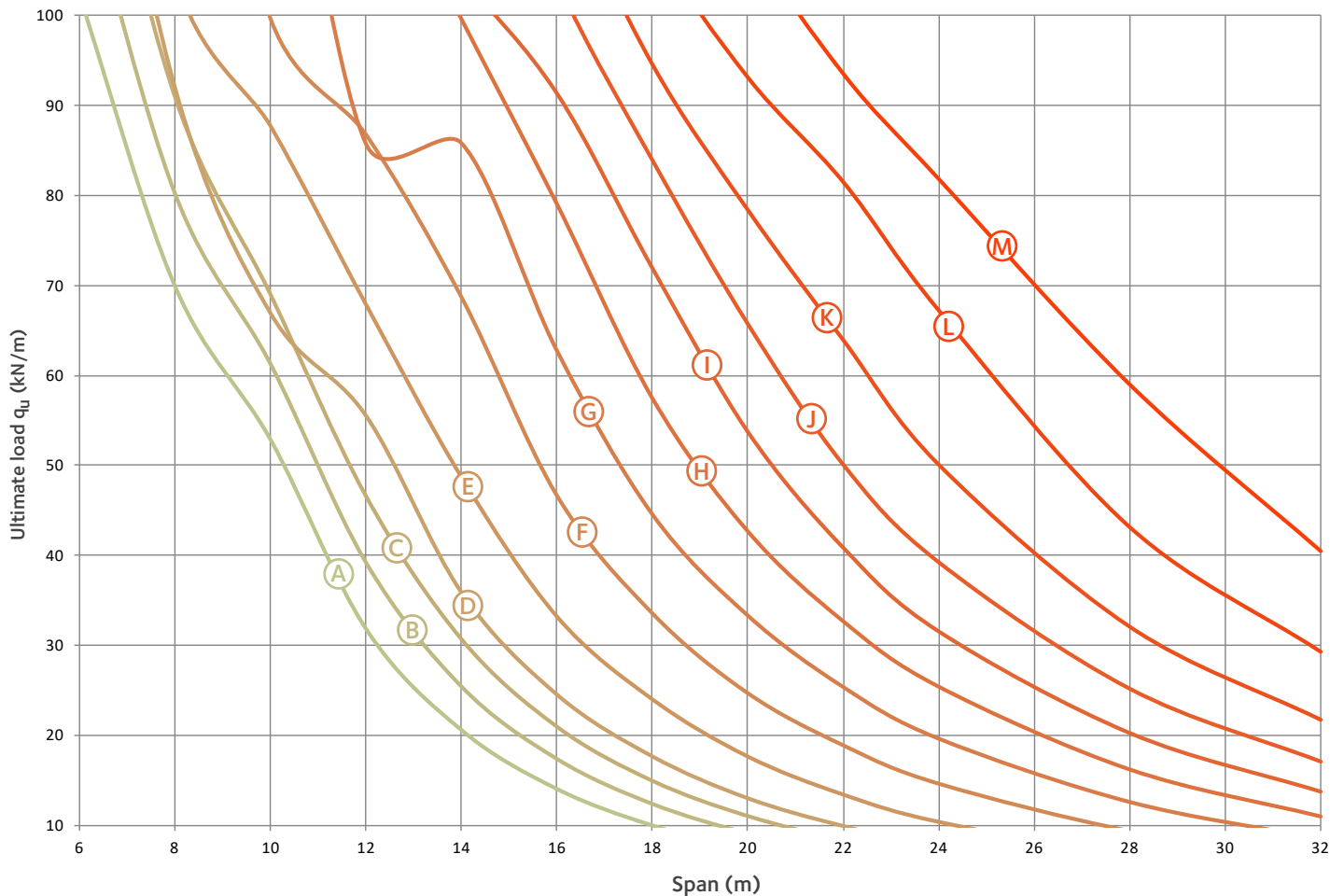

Sections		Dimensions (mm)					Ultimate load q_u (kN/m) according to the span (m)												
		a_0	w	s	e	H_t	6	8	10	12	14	16	18	20	22	24	28	32	
(A)	HE 300 A	305	200	305	1010	442,5		69,9	52,9	31,8	20,6	14,1	10,0						
(B)	HE 320 A	325	200	325	1050	472,5		80,3	61,4	39,3	25,5	17,4	12,4						
(C)	HE 340 A	340	200	340	1080	500		91,0	69,0	46,6	30,7	20,9	14,9	11,0					
(D)	HE 360 A	365	250	365	1230	532,5		92,1	67,0	55,6	35,9	24,6	17,7	13,0	10,0				
(E)	HE 400 A	405	250	405	1310	592,5			87,8	68,0	48,8	33,3	24,1	17,7	13,5	10,4			
(F)	HE 450 A	455	250	455	1410	667,5			99,7	86,8	68,7	46,7	33,6	24,7	18,9	14,6			
(G)	HE 500 A	500	250	500	1500	740				85,8	85,9	62,8	44,6	33,3	25,4	19,6	12,6		
(H)	HE 550 A	555	250	555	1610	817,5					99,7	79,1	57,5	42,7	32,7	25,4	16,2	11,0	
(I)	HE 600 A	600	250	600	1700	890						91,4	71,9	53,7	40,8	31,5	20,2	13,7	
(J)	HE 650 A	655	250	655	1810	967,5							83,9	65,7	50,1	39,2	25,2	17,1	
(K)	HE 700 A	755	250	755	2010	1067,5								94,6	78,4	64,0	50,1	32,1	21,8
(L)	HE 800 A	805	250	805	2110	1192,5									93,1	81,5	67,2	43,1	29,2
(M)	HE 900 A	900	250	900	2300	1340										93,6	81,9	59,1	40,5

Chart 19: Composite Angelina® based on IPE, S355 with COFRAPLUS 60

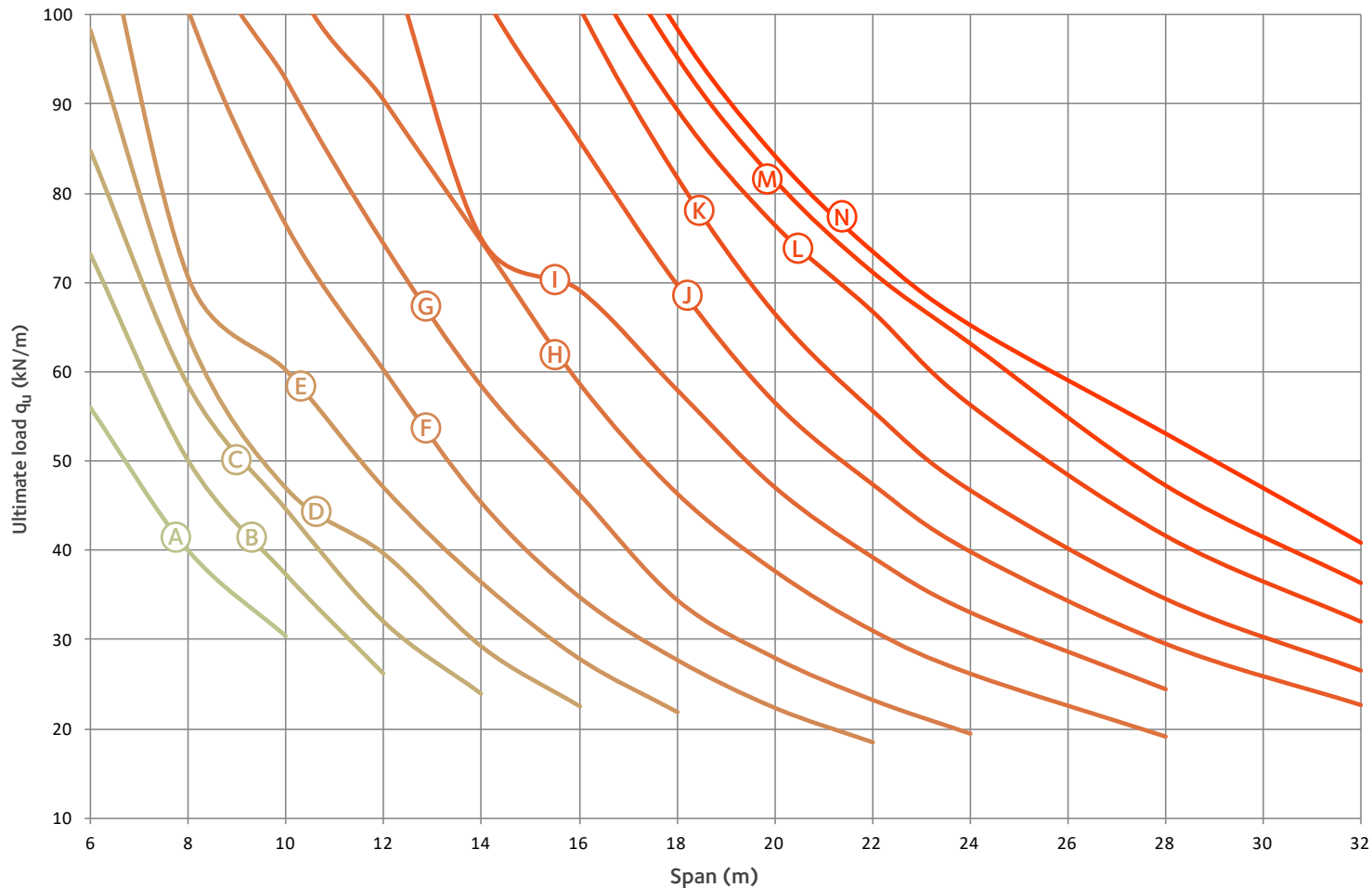

Sections		Dimensions (mm)					Ultimate load q_u (kN/m) according to the span (m)															
		a_0	w	s	e	H_t	6	8	10	12	14	16	18	20	22	24	28	32				
Ⓐ	IPE 270	285	200	285	970	412,5	56,0	40,0	30,3													
Ⓑ	IPE 300	315	200	315	1030	457,5	73,1	50,0	37,3	26,2												
Ⓒ	IPE 330	345	200	345	1090	502,5	84,7	58,5	44,6	32,0	23,9											
Ⓓ	IPE 360	375	250	375	1250	547,5	98,2	63,9	46,9	39,6	29,1	22,5										
Ⓔ	IPE 400	415	250	415	1330	607,5	116,9	70,6	60,2	47,0	36,4	27,9	21,9									
Ⓕ	IPE 450	465	250	465	1430	682,5	136,3	100,6	76,4	60,2	45,3	34,8	27,7	22,3	18,5							
Ⓖ	IPE 500	515	250	515	1530	757,5		114,1	92,8	74,3	58,4	46,3	34,4	27,9	23,2	19,4						
Ⓗ	IPE 550	555	250	555	1610	827,5		159,8	106,9	90,5	74,7	58,8	46,5	37,8	31,1	26,3	19,2					
Ⓘ	IPE 600	615	250	615	1730	907,5			137,8	108,6	75,0	69,2	58,1	47,1	39,3	33,1	24,5					
Ⓙ	IPE 750 x 134	755	250	755	2010	1130,5				125,8	102,8	86,0	69,8	56,6	47,4	39,9	29,5	22,7				
Ⓚ	IPE 750 x 147	755	250	755	2010	1130,5				152,8	125,1	101,0	81,8	66,6	55,7	46,7	34,6	26,5				
Ⓛ	IPE 750 x 173	765	250	765	2030	1144,5					135,3	107,7	89,5	76,5	66,8	56,3	41,7	32,0				
Ⓜ	IPE 750 x 196	770	250	770	2040	1155					144,1	114,8	95,3	81,5	71,2	63,2	47,3	36,4				
Ⓝ	IPE 750 x 220	780	250	780	2060	1169					148,8	118,5	98,5	84,2	73,5	65,2	53,1	40,8				

Chart 20: Composite Angelina® based on HEA, S355 with COFRAPLUS 60

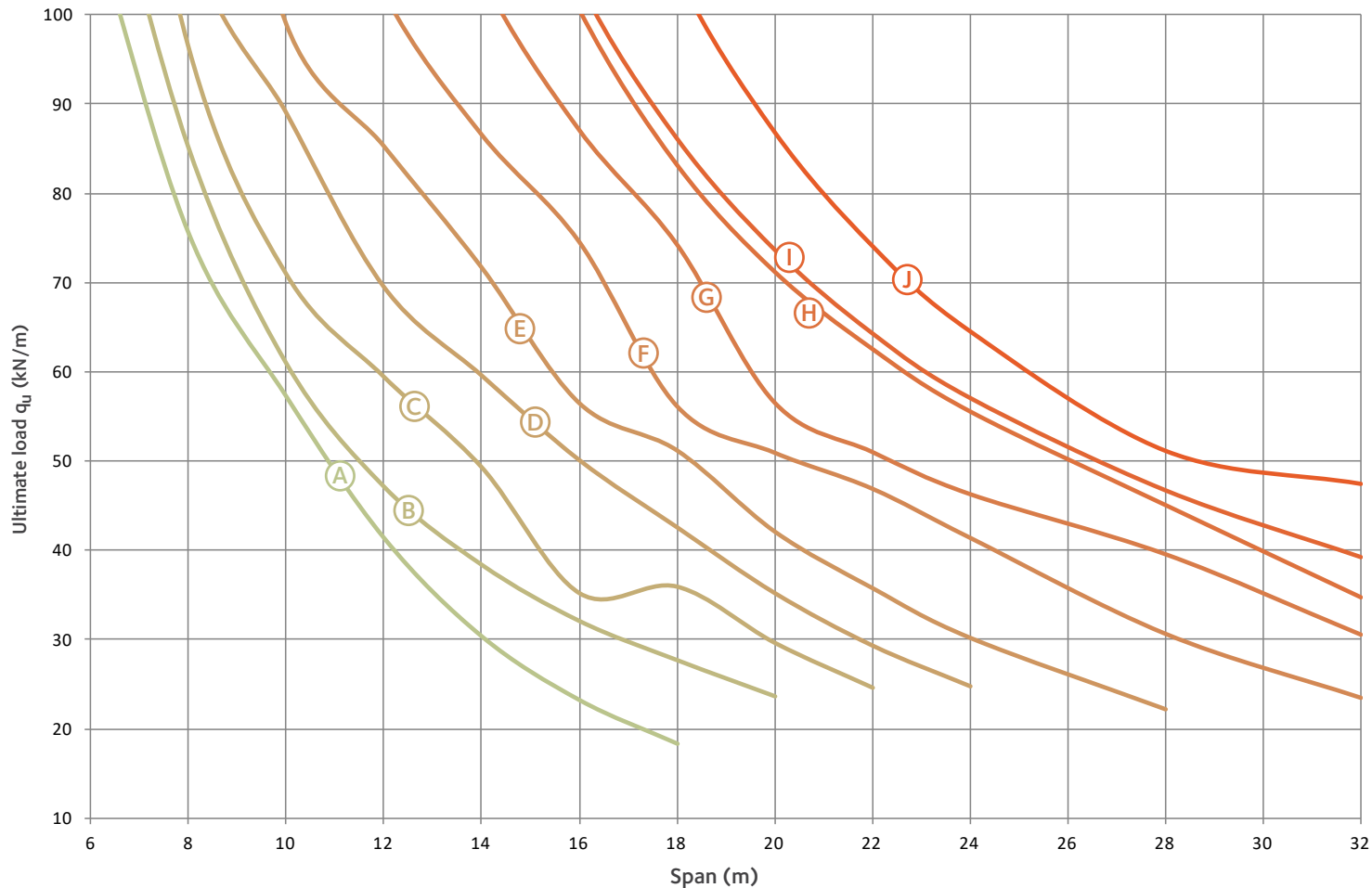

Sections	Dimensions (mm)					Ultimate load q_u (kN/m) according to the span (m)											
	a_0	w	s	e	H_t	6	8	10	12	14	16	18	20	22	24	28	32
(A) HE 300 A	305	200	305	1010	442,5	111,6	75,7	57,3	41,4	30,4	23,2	18,3					
(B) HE 320 A	325	200	325	1050	472,5	124,9	85,3	61,0	47,2	38,4	32,1	27,7	23,6				
(C) HE 360 A	365	250	365	1230	532,5	150,9	96,5	71,0	59,4	49,3	35,2	35,9	29,6	24,6			
(D) HE 400 A	405	250	405	1310	592,5		109,8	89,1	69,6	59,7	50,2	42,7	35,3	29,4	24,8		
(E) HE 450 A	455	250	455	1410	667,5		143,7	99,1	85,4	71,8	56,5	51,2	42,1	35,8	30,2	22,2	
(F) HE 550 A	555	250	555	1610	817,5			128,1	102,5	86,7	74,6	56,2	51,0	47,0	41,5	30,7	23,5
(G) HE 650 A	655	250	655	1810	967,5				130,5	104,5	87,1	74,3	56,6	51,0	46,3	39,6	30,6
(H) HE 700 A	755	250	755	2010	1067,5					125,4	100,6	83,2	71,2	62,6	55,6	45,1	34,7
(I) HE 800 A	805	250	805	2110	1192,5					130,2	103,7	86,1	73,7	64,3	57,0	46,7	39,2
(J) HE 900 A	900	250	900	2300	1340					128,2	131,8	104,8	86,9	74,1	64,5	51,1	47,4

Chart 21: Composite Angelina® based on HEB, S355 with COFRAPLUS 60

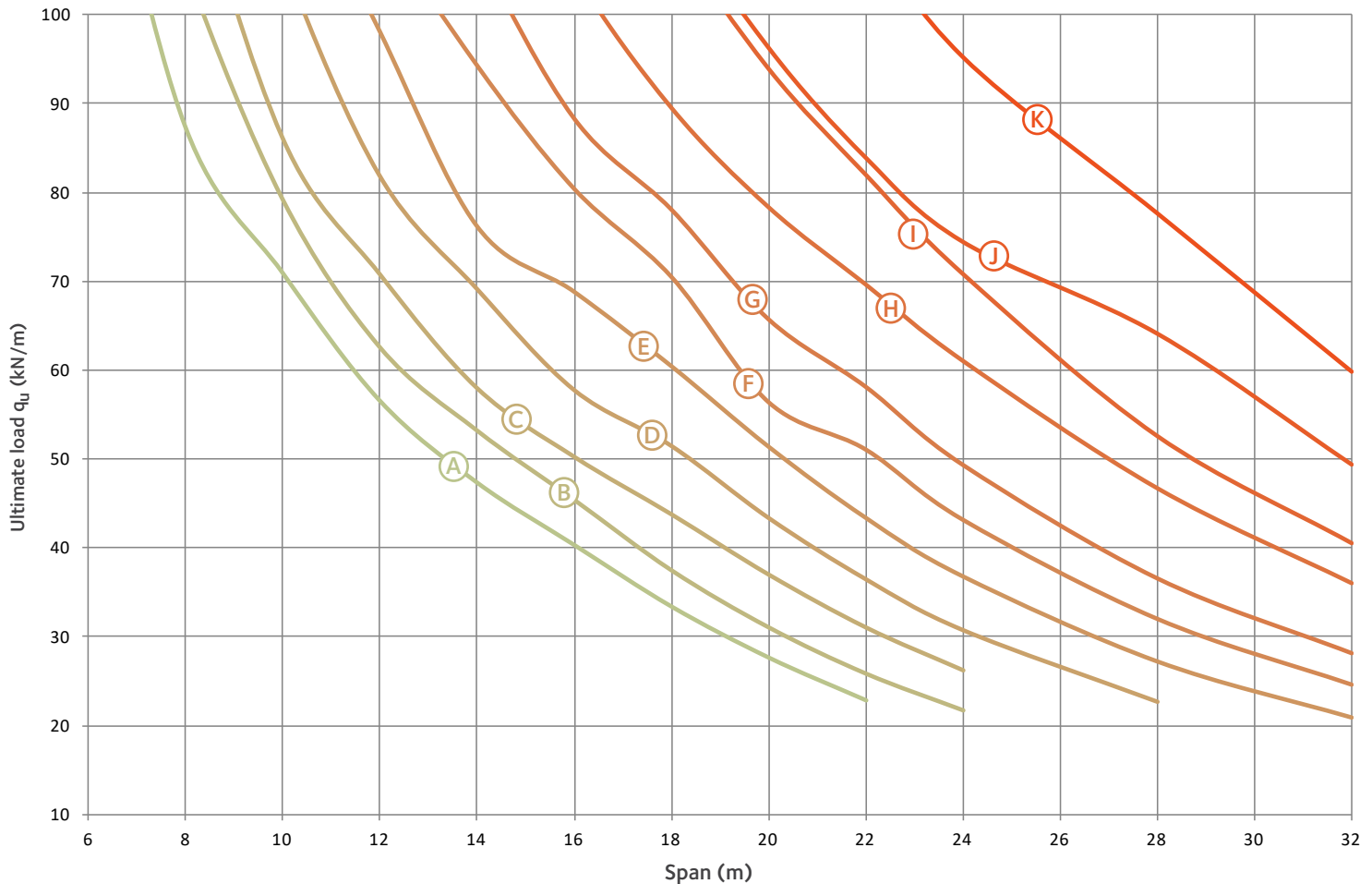

Sections		Dimensions (mm)					Ultimate load q_u (kN/m) according to the span (m)											
		a_0	w	s	e	H_t	6	8	10	12	14	16	18	20	22	24	28	32
Ⓐ	HE 300 B	315	250	315	1130	457,5	129,3	87,5	71,0	56,6	47,4	40,4	33,5	27,7	22,9			
Ⓑ	HE 320 B	335	250	335	1170	487,5	138,5	105,6	79,3	62,6	53,3	45,4	37,5	31,1	25,9	21,7		
Ⓒ	HE 360 B	380	300	380	1360	550		120,6	86,2	70,8	58,0	50,3	43,8	37,0	31,0	26,2		
Ⓓ	HE 400 B	420	300	420	1440	610		137,9	106,4	81,9	69,1	57,7	51,4	43,3	36,4	30,7	22,6	
Ⓔ	HE 450 B	475	300	475	1550	687,5		151,5	120,9	98,1	76,2	68,8	60,4	51,3	43,3	36,7	27,2	20,8
Ⓕ	HE 500 B	525	300	525	1650	762,5			132,4	111,1	94,3	80,4	70,5	56,4	51,1	43,2	32,0	24,6
Ⓖ	HE 550 B	580	300	580	1760	840				130,6	107,7	88,4	78,1	65,7	58,1	49,4	36,6	28,2
Ⓗ	HE 650 B	680	300	680	1960	990				153,2	125,4	104,8	89,5	78,3	69,6	61,0	46,7	36,0
Ⓘ	HE 700 B	730	300	730	2060	1065					154,9	130,7	109,8	94,0	82,0	70,9	52,6	40,5
Ⓙ	HE 800 B	780	300	780	2160	1190						136,3	112,6	96,3	83,9	74,4	64,1	49,4
Ⓚ	HE 900 B	830	350	830	2360	1315							155,9	128,6	109,9	95,2	77,7	59,8

Chart 22: Composite Angelina® based on HD, S355 with COFRAPLUS 60

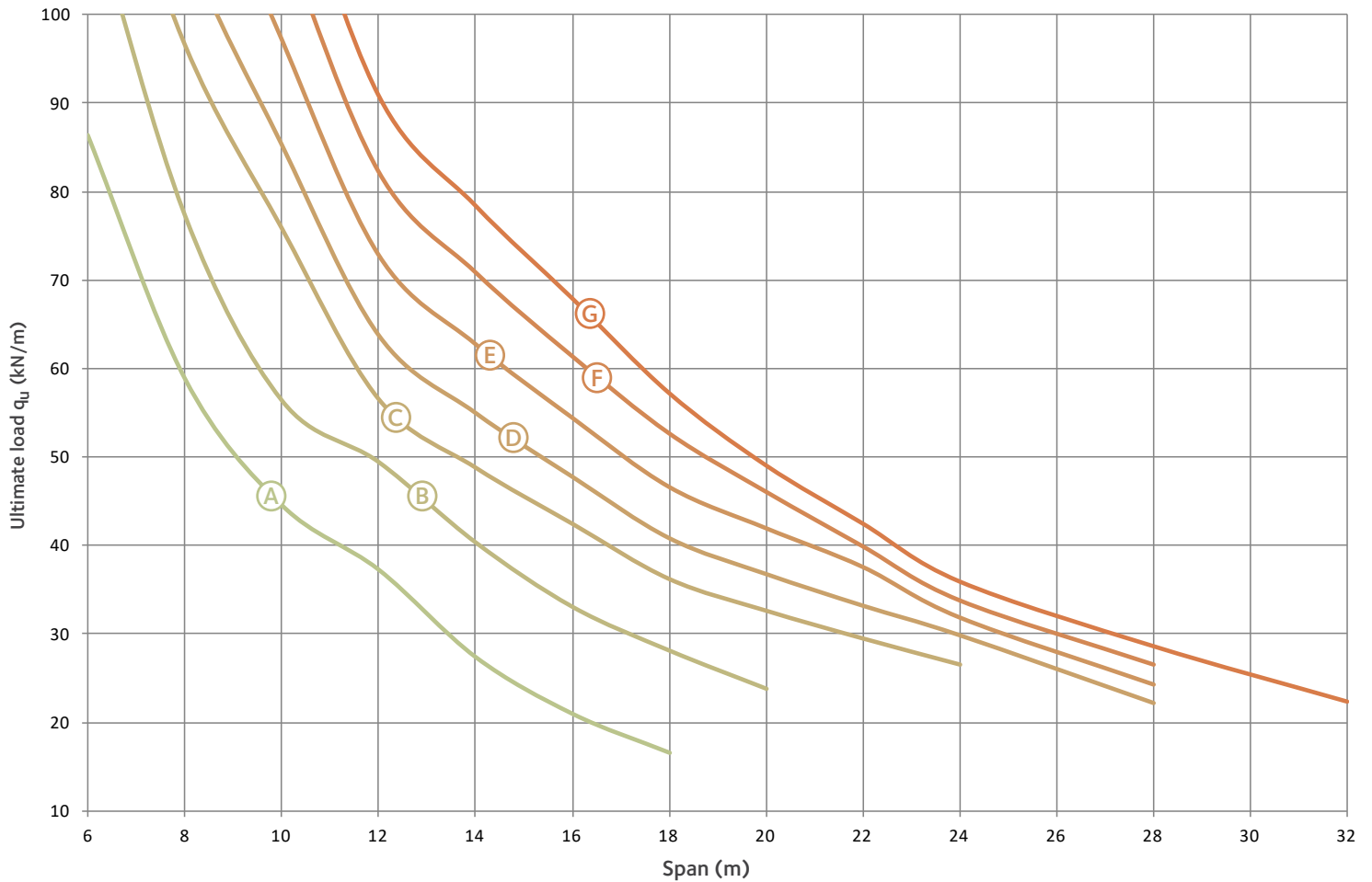

Sections	Dimensions (mm)					Ultimate load q_u (kN/m) according to the span (m)												
	a_0	w	s	e	H_t	6	8	10	12	14	16	18	20	22	24	30	32	
Ⓐ	HD 320 x 74.2	350	200	350	1100	476	86,4	58,9	44,6	37,3	27,4	21,0	16,6					
Ⓑ	HD 320 x 97.6	350	200	350	1100	485	113,6	77,4	56,5	49,5	40,4	33,1	28,2	23,9				
Ⓒ	HD 360 x 147	440	300	440	1480	580	128,4	96,6	75,9	56,6	48,8	42,4	36,2	32,6	29,5	26,5		
Ⓓ	HD 360 x 162	440	300	440	1480	584	144,4	108,8	85,4	63,8	55,0	47,8	40,8	36,8	33,2	29,8	22,2	
Ⓔ	HD 360 x 179	440	300	440	1480	588		124,2	97,3	72,9	62,8	54,5	46,7	42,0	37,6	31,9	24,3	
Ⓕ	HD 360 x 196	440	300	440	1480	592		140,1	109,6	82,3	70,9	61,4	52,7	46,1	39,9	33,8	26,6	
Ⓖ	HD 400 x 216	440	300	440	1480	595		155,0	121,2	90,9	78,4	67,9	57,2	49,0	42,4	35,9	28,6	22,3

Chart 23: Composite Angelina® based on HEA, HISTAR® 460 with COFRAPLUS 60

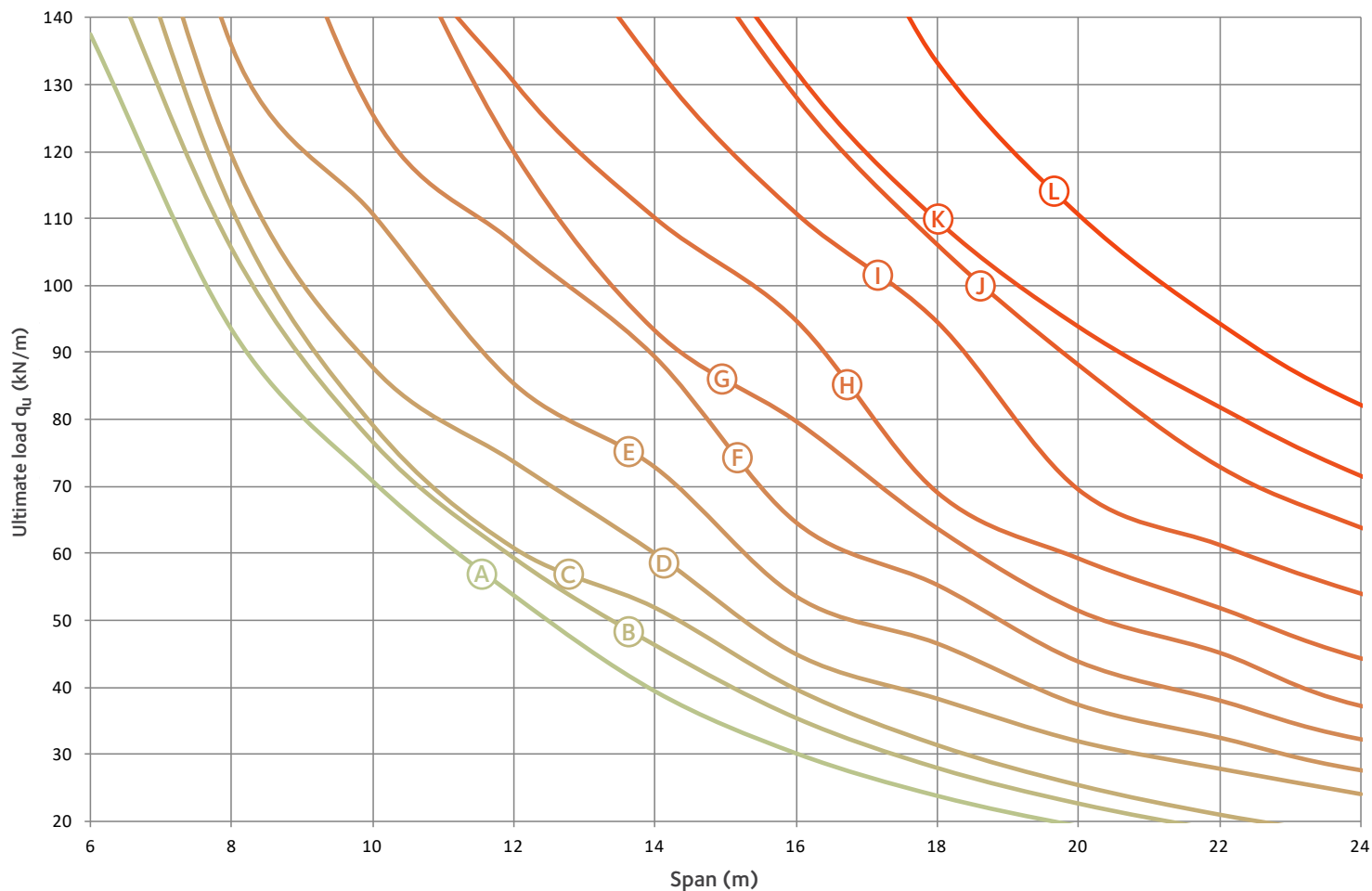

Sections	Dimensions (mm)					Ultimate load q_u (kN/m) according to the span (m)										
	a_0	w	s	e	H_t	6	8	10	12	14	16	18	20	22	24	
(A) HE 300 A	305	200	305	1010	442,5	137,5	93,4	70,7	53,7	39,4	30,1	23,8	19,2	15,9		
(B) HE 320 A	325	200	325	1050	472,5		105,6	76,7	59,3	46,3	35,4	27,9	22,6	18,6	15,7	
(C) HE 340 A	340	200	340	1080	500		111,6	79,3	60,9	52,0	39,8	31,4	25,5	21,0	17,7	
(D) HE 360 A	365	250	365	1230	532,5		119,5	87,8	73,7	60,0	44,9	38,3	31,9	27,8	24,0	
(E) HE 400 A	405	250	405	1310	592,5		135,9	110,7	85,4	72,9	53,6	46,5	37,4	32,5	27,6	
(F) HE 450 A	455	250	455	1410	667,5			125,6	106,4	89,4	64,7	55,4	43,9	38,1	32,3	
(G) HE 500 A	500	250	500	1500	740				120,0	93,3	79,8	63,8	51,4	45,2	37,2	
(H) HE 550 A	555	250	555	1610	890				130,4	110,1	94,7	69,0	59,2	51,8	44,3	
(I) HE 650 A	655	250	655	1810	967,5					132,9	110,8	94,6	69,6	61,3	54,0	
(J) HE 700 A	755	250	755	2010	1067,5						128,1	106,1	88,1	72,9	63,8	
(K) HE 800 A	805	250	805	2110	1192,5						132,1	109,8	93,9	81,9	71,6	
(L) HE 900 A	900	250	900	2300	1340							133,4	110,6	94,4	82,2	

Chart 24: Composite Angelina® based on HEB, HISTAR® 460 with COFRAPLUS 60

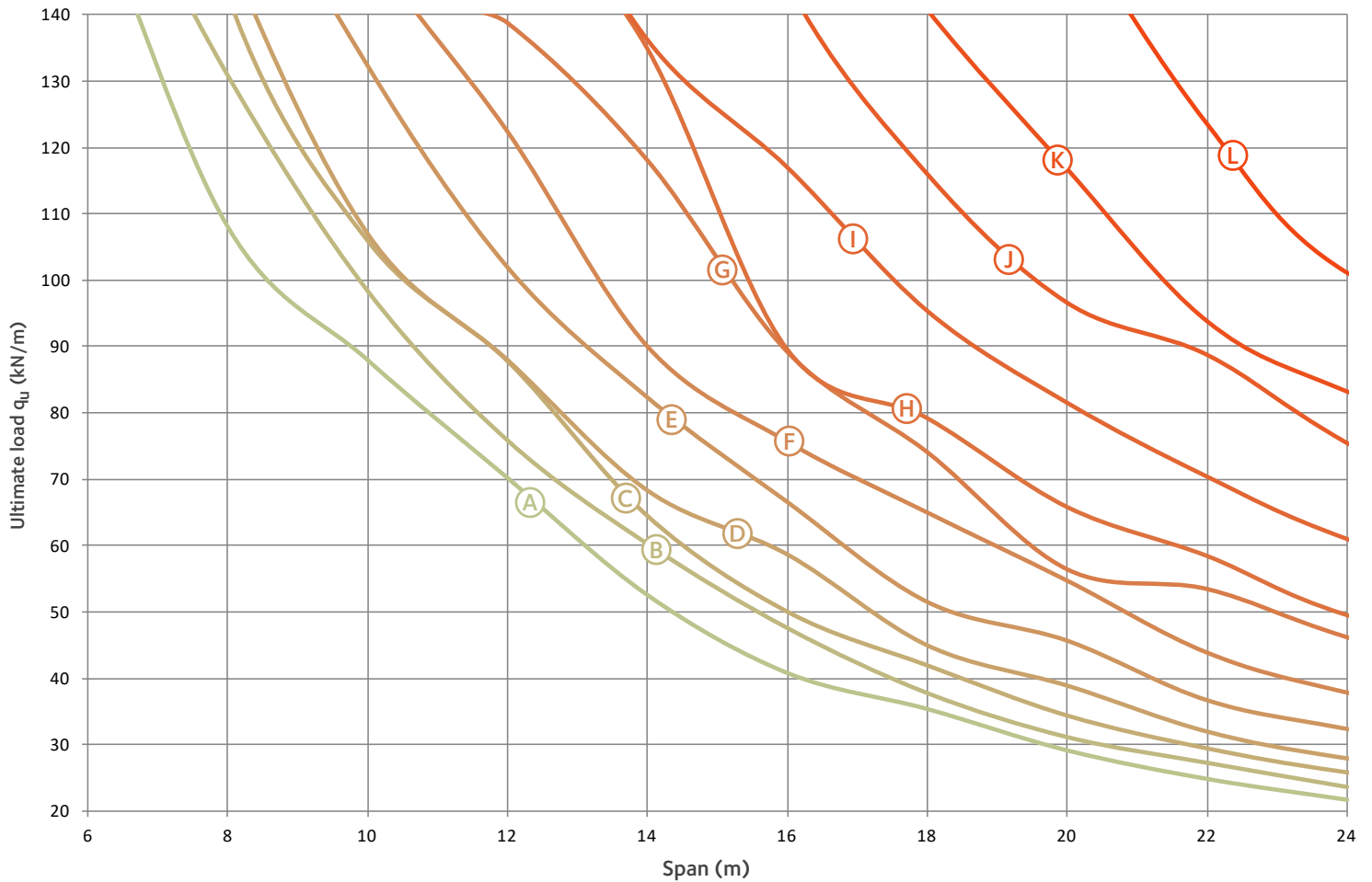

Sections	Dimensions (mm)					Ultimate load q_u (kN/m) according to the span (m)										
	a_0	w	s	e	H_t	6	8	10	12	14	16	18	20	22	24	
Ⓐ	HE 300 B	315	250	315	1130	457,5		108,2	88,0	70,2	52,6	40,8	35,4	29,1	24,8	21,7
Ⓑ	HE 320 B	335	250	335	1170	487,5		131,0	98,5	76,0	60,3	47,7	37,8	31,2	27,3	23,7
Ⓒ	HE 340 B	355	250	355	1210	517,5			106,0	87,8	64,5	50,0	41,9	34,3	29,4	25,8
Ⓓ	HE 360 B	380	300	380	1360	550			107,1	88,0	68,4	58,7	45,0	38,9	32,0	28,0
Ⓔ	HE 400 B	420	300	420	1440	610			132,4	102,0	82,4	66,6	51,5	45,7	36,7	32,4
Ⓕ	HE 450 B	475	300	475	1550	687,5				122,5	90,1	75,7	65,0	54,8	43,9	37,9
Ⓖ	HE 500 B	525	300	525	1650	762,5				138,8	118,1	89,2	74,1	56,4	53,4	46,2
Ⓗ	HE 550 B	580	300	580	1760	840					134,8	89,5	79,1	65,7	58,4	49,5
Ⓘ	HE 650 B	680	300	680	1960	990					136,3	117,0	95,4	81,5	70,4	61,0
Ⓙ	HE 700 B	730	300	730	2060	1065						116,1	96,7	88,8	75,5	
Ⓚ	HE 800 B	780	300	780	2160	1190							116,7	93,8	83,2	
Ⓛ	HE 900 B	830	350	830	2360	1315								123,6	101,1	

Chart 25: Composite Angelina® based on HD, HISTAR® 460 with COFRAPLUS 60

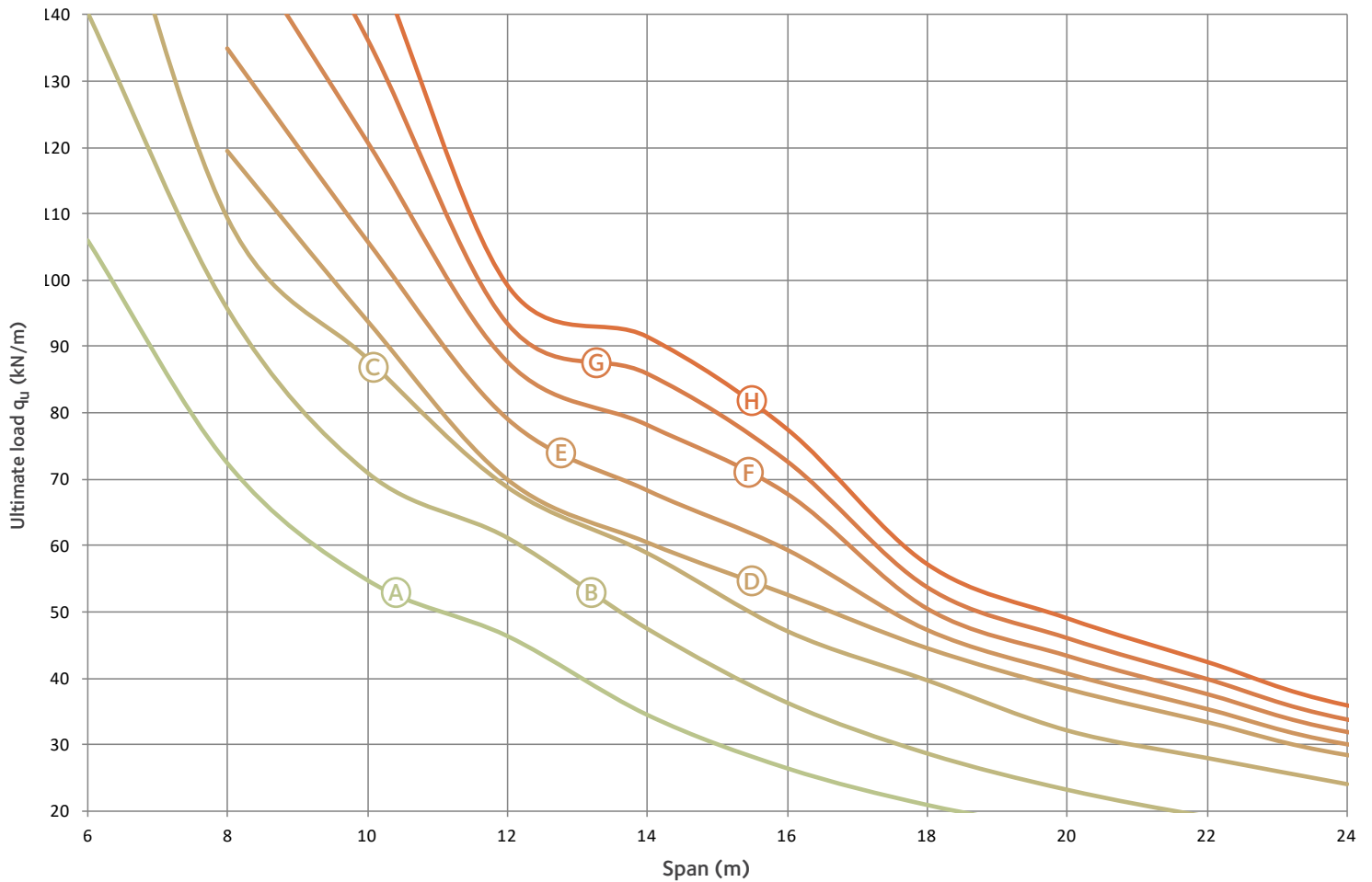

Sections	Dimensions (mm)					Ultimate load q_u (kN/m) according to the span (m)										
	a_0	w	s	e	H_t	6	8	10	12	14	16	18	20	22	24	
(A)	HD 320 x 74.2	350	200	350	1100	476	106,1	72,4	54,8	46,3	34,4	26,4	20,8	16,9		
(B)	HD 320 x 97.6	350	200	350	1100	485		95,6	71,0	61,2	47,5	36,4	28,7	23,3	19,2	16,2
(C)	HD 320 x 127	350	300	350	1300	495		109,3	88,2	68,8	58,8	47,1	39,7	32,1	28,0	24,0
(D)	HD 360 x 147	440	300	440	1480	580		119,5	93,9	70,0	60,5	52,6	44,5	38,4	33,4	28,4
(E)	HD 360 x 162	440	300	440	1480	584		134,8	105,9	79,1	68,3	59,3	47,3	40,7	35,4	30,1
(F)	HD 360 x 179	440	300	440	1480	588			120,9	87,7	78,2	67,8	50,5	43,4	37,6	31,9
(G)	HD 360 x 196	440	300	440	1480	592			136,5	93,6	86,0	72,8	53,8	46,1	39,9	33,8
(H)	HD 400 x 216	440	300	440	1480	595				99,3	91,5	77,6	57,2	49,0	42,4	35,9

Chart 26: Composite Angelina® based on HD, S355 with Cofradal 200

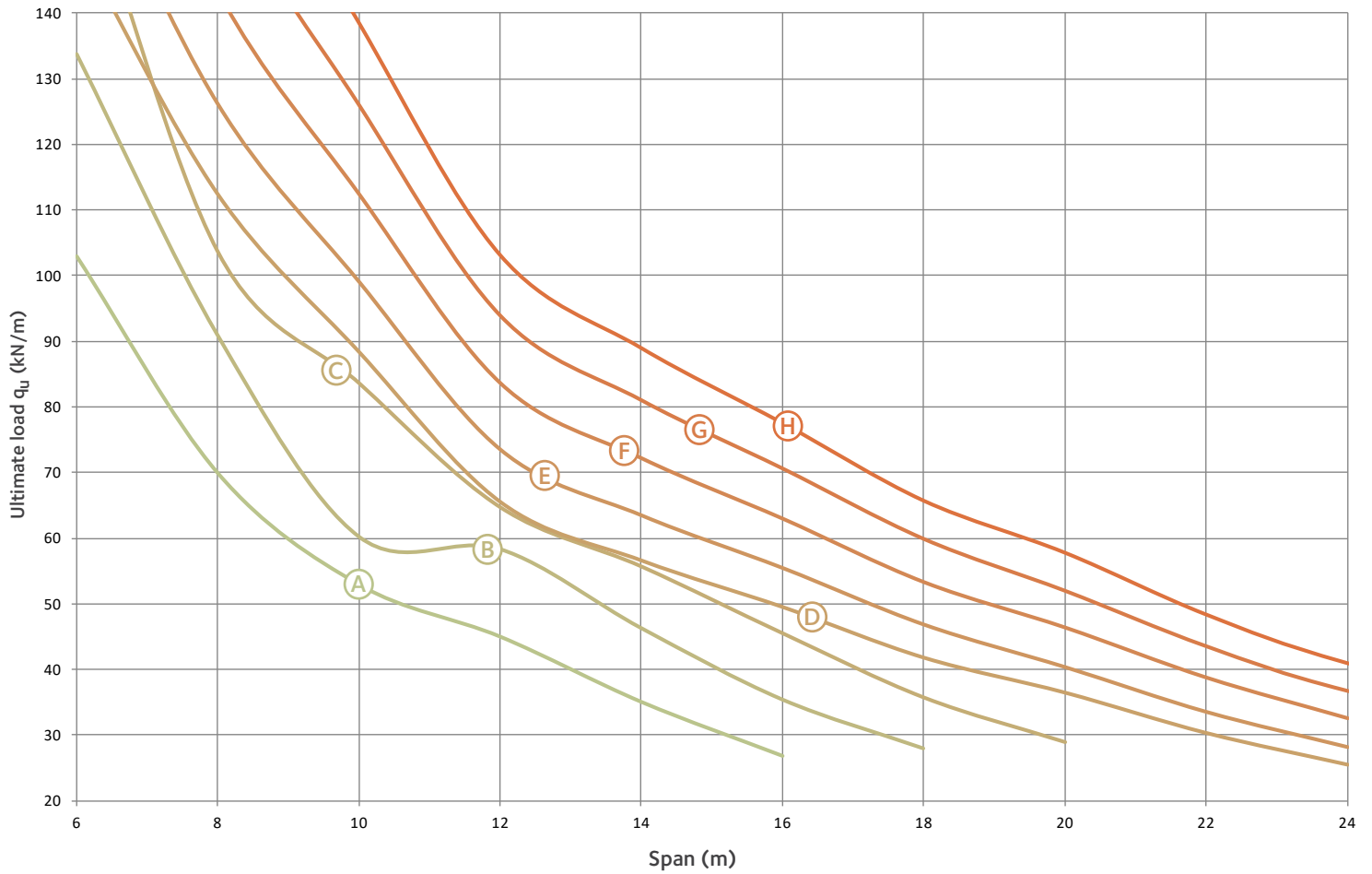

Sections	Dimensions (mm)						Ultimate load q_u (kN/m) according to the span (m)									
	a_0	w	s	e	H_t	6	8	10	12	14	16	18	20	22	24	
(A)	HD 320 x 74.2	350	200	350	1100	476	102,9	69,9	52,9	45,0	35,0	26,8				
(B)	HD 320 x 97.6	350	200	350	1100	485	133,8	90,9	60,3	58,4	46,3	35,5	28,0			
(C)	HD 320 x 127	350	300	350	1300	495		103,6	83,6	64,8	55,7	45,6	35,8	29,0		
(D)	HD 360 x 147	440	300	440	1480	580		112,4	88,3	65,5	56,5	49,4	41,7	36,4	30,2	25,4
(E)	HD 360 x 162	440	300	440	1480	584		126,1	99,0	73,5	63,4	55,4	46,8	40,3	33,5	28,1
(F)	HD 360 x 179	440	300	440	1480	588			112,3	83,6	72,1	62,9	53,2	46,3	38,7	32,5
(G)	HD 360 x 196	440	300	440	1480	592			126,0	93,9	81,0	70,6	59,8	51,9	43,5	36,7
(H)	HD 400 x 216	440	300	440	1480	595			138,5	103,2	89,0	77,6	65,8	57,8	48,4	41,0

Chart 27: Composite Angelina® based on HD, HISTAR® 460 with Cofradal 200

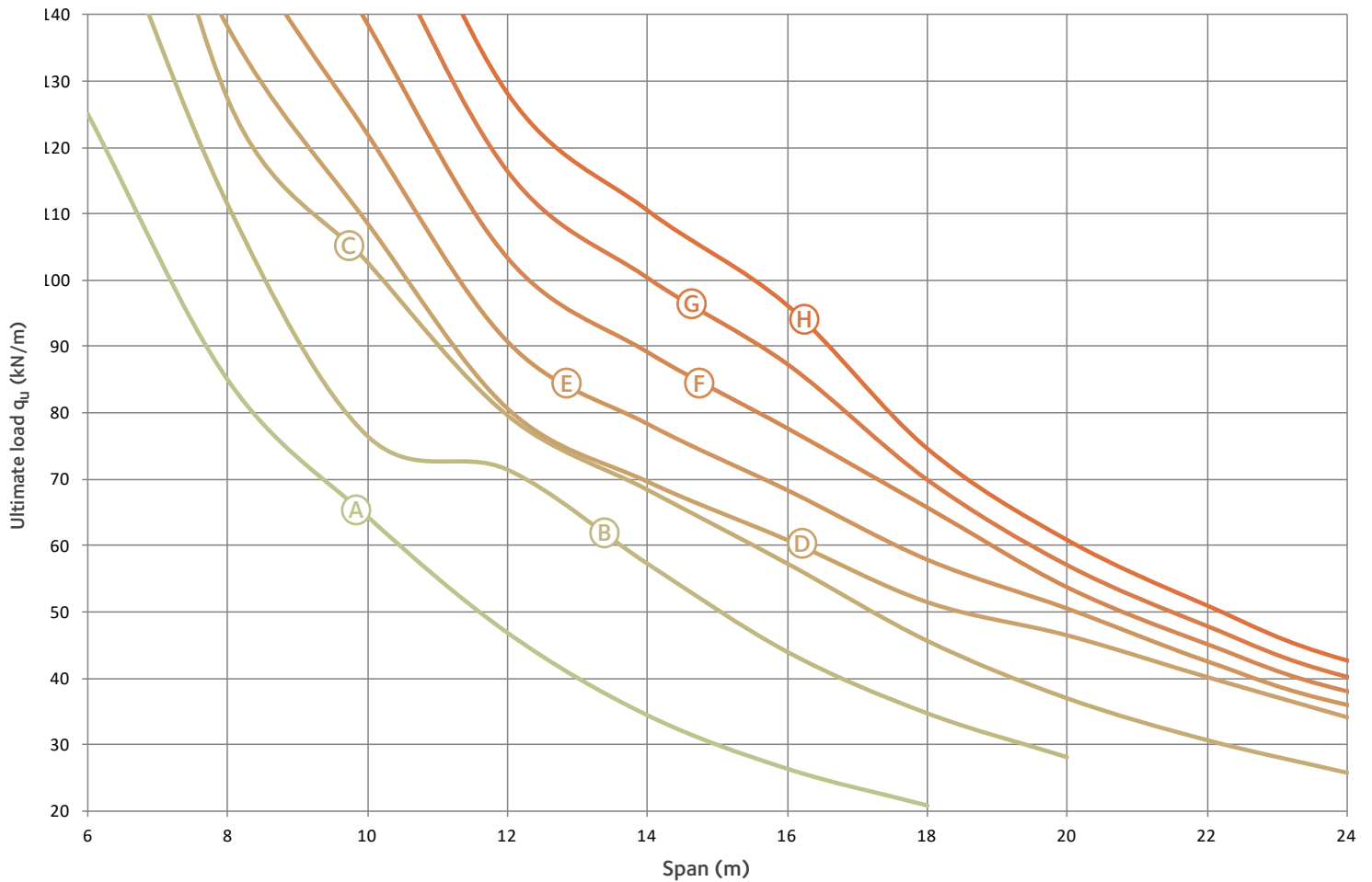

Sections	Dimensions (mm)					Ultimate load q_u (kN/m) according to the span (m)											
	a_0	w	s	e	H_t	6	8	10	12	14	16	18	20	22	24		
(A)	HD 320 x 74.2	350	200	350	1100	476	125,1	85,0	64,4	46,9	34,4	26,4	20,8				
(B)	HD 320 x 97.6	350	200	350	1100	485		111,4	76,5	71,5	57,3	44,1	34,8	28,2			
(C)	HD 320 x 127	350	300	350	1300	495		127,3	102,7	79,7	68,4	57,3	45,7	37,0	30,7	25,8	
(D)	HD 360 x 147	440	300	440	1480	580		138,2	108,6	80,6	69,6	60,8	51,4	46,4	40,1	34,0	
(E)	HD 360 x 162	440	300	440	1480	584			122,0	90,7	78,3	68,3	57,8	50,5	42,5	36,0	
(F)	HD 360 x 179	440	300	440	1480	588			138,7	103,4	89,2	77,7	65,8	53,8	45,2	38,1	
(G)	HD 360 x 196	440	300	440	1480	592				116,5	100,4	87,4	70,0	57,1	47,9	40,3	
(H)	HD 400 x 216	440	300	440	1480	595					128,2	110,6	96,3	74,7	60,9	51,0	42,8



13. Our support to your project

- Technical support

We help you in designing and developing innovative solutions to take the best advantage of our steel. We are happy to provide free technical advice and to answer your questions about the use of sections and merchant bars. This technical advice covers the design of structural elements, construction details, surface protection, fire safety, metallurgy and welding.

Our specialists are ready to support your initiatives anywhere in the world and to provide tailor made services to help you get better result faster with our steel.

sections.sales@arcelormittal.com

- Finishing

As a complement to the technical capacities of our partners, we are equipped with high-performance finishing tools and offer a wide range of services, such as: drilling, flame cutting, T cut-outs, notching, cambering, curving, straightening, cold sawing to exact length, welding and fitting of studs, shot and sand blasting, surface treatment.

- Our expertise

ArcelorMittal, the world's leading steel and mining company, has continuously brought, with the support of its R&D teams, innovation to the construction business. In that matter, ArcelorMittal has decided to look at the construction in a different way, by considering the building as part of its environment and through its entire lifecycle. This new approach is called **Steligence®**.

In Europe, to help project stakeholders (architects, real estate companies, engineer), ArcelorMittal has developed a network of Steligence® Construction Engineers applying a science-based methodology, which considers buildings holistically and demonstrate the benefits of best-in-class products in terms of economics, flexibility, sustainability and creativity.

Resources:

software and technical documentation :

sections.arcelormittal.com

examples of our full range of products for the construction market (structures, façades, roofing, etc.):

constructalia.arcelormittal.com

Contact us for technical support:

For European market:

steligenge.engineering@arcelormittal.com

For other markets:

sections.sales@arcelormittal.com

More info about Steligence® :

steligenge.arcelormittal.com

Contact

Technical advisory

ArcelorMittal Commercial Sections S.A.

66, rue de Luxembourg
L-4221 Esch-sur-Alzette
LUXEMBOURG

Tel.: + 352 5313 3010
sections.arcelormittal.com

Fabrication

Steligence® Fabrication Centre

Z.I. Gadderscheier
L-4984 Sanem
LUXEMBOURG

Tel.: +352 5313 3057
steligence.fabrication@arcelormittal.com

Sales

We operate in more than 60 countries on the five continents.
Find your local agency at sections.arcelormittal.com/About us.

